

OPTOMETRIC EXTENSION PROGRAM FOUNDATION

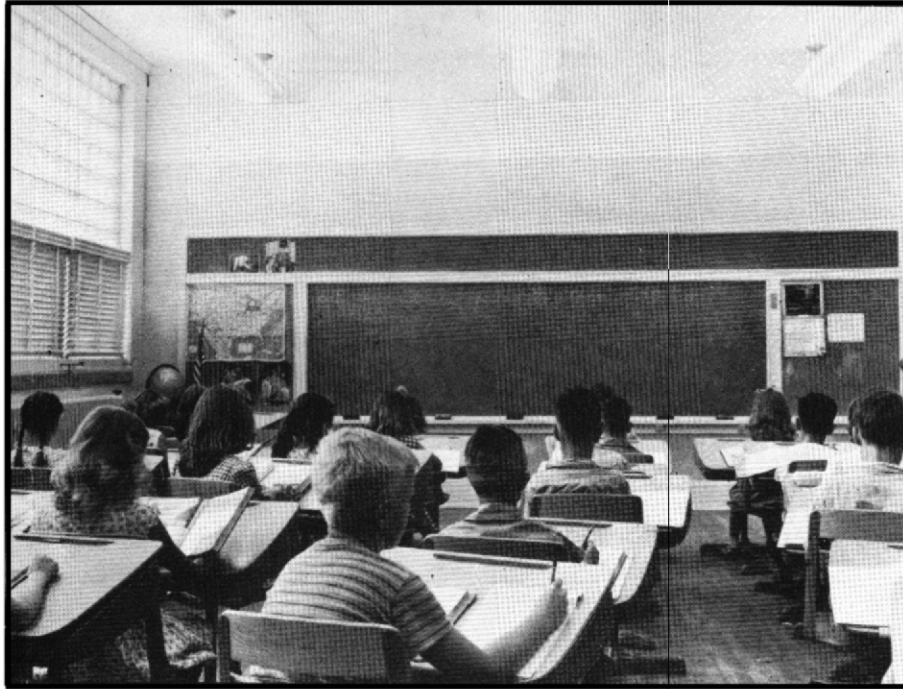

The
**COORDINATED
CLASSROOM**

By
Darell Boyd Harmon

AMERICAN SEATING COMPANY

EXECUTIVE OFFICES:
NINTH AND BROADWAY
GRAND RAPIDS, MICHIGAN

H. M. TALIAFERRO
PRESIDENT

For more than thirty years, the management of American Seating Company has been acutely interested in research affecting the welfare of the school child. During the past decade, American youth has been materially benefited by features of posture and sight conservation which it has been our privilege to build into school seating—benefits that have been largely the result of educational research by Dr. Henry Eastman Bennett in the latter years of his life.

In more recent years, intensive research activities conducted for the Texas State Department of Health and the Texas Inter-Professional Commission on Child Development have attracted the attention and intense interest of our management. Research of such a scientific nature cannot be ignored or minimized by educators, architects or school-building authorities, or by manufacturers of school-room equipment. There is too much at stake for the future of this nation for us to disregard the benefits which these scientific research activities have disclosed as seriously affecting the welfare of the school child.

It is with these considerations in mind that the management of American Seating Company takes pleasure in making available to interested school authorities the results of such scientific studies as are covered by this brochure, "The Co-ordinated Classroom." We believe Dr. Darell Boyd Harmon has had unprecedented opportunities and scientific facilities for conducting these research activities in school classrooms during the past ten years.



DARELL BOYD HARMON, (A.B., M.A., Colorado College; Ph.D., New York University), specializes in the study of the processes of growth and development in the school child with emphasis on the psycho-physiological and visually-centered aspects of learning, together with the effect of the environment on those processes. For ten years he was Director, Division of School Services, Texas State Department of Health, following an extensive career in educational research and teacher education. He now practices as a consulting educationist for school systems and architects; serves on the visiting staffs of a number of colleges and universities; and acts as research and design consultant for several manufacturers of equipment used in schools to aid in assuring them that their products meet the needs of growing children.

Data used in this paper have been drawn for the studies made in the Texas State Department of Health, and from other sources. However, the hypotheses, applications and conclusions contained herein are the writer's own, and he alone, should be held responsible for their validity.

— DARELL BOYD HARMON

The CO-ORDINATED CLASSROOM

by DARELL BOYD HARMON

The human organism strives to grow, develop, and function as an integrated whole. In each of its responses to the forces or restraints in its environment which stimulate it, it performs organically by seeking physical balances with those forces and restraints which meet certain functions on inherently determined systems of co-ordinates. These responses have a large share in determining the organism's later developments, efficiencies, and well-being.

The work environment of the immature organism (the child) must be equally co-ordinated with the organism itself, if we would have the child arrive at an optimum maturity, fully capable of using its resources and developmental experiences in meeting its needs in an efficient, acceptable, and satisfying manner.

Part One

THE CLASSROOM AS A HAZARD TO CHILD DEVELOPMENT

THE Texas State Department of Health, in January, 1938, launched a long-range program in child development as part of its services for protecting and promoting the health of school children. This program had been suggested by a group of school administrators and educational leaders who made up the Committee on Child Health of the Texas State Teachers' Association, after consultation with leaders in medicine and other professions concerned.

An administrative unit was set up in the Texas State Department of Health to carry on the new service, and this division was placed under the direction of a specialist in education and child development. The school systems of Texas, the state's colleges and teacher-training institutions, and similar agencies, were invited to collaborate.

Fourteen state professional societies and organizations, including the Texas State Teachers' Association, the State Medical Association of Texas, the Texas State Dental Society, the Illuminating Engineering Society, the Texas Society of Architects, and organizations of educational and medical specialties, officially formed the Texas Inter-Professional Commission on Child Development to work with the program. The purpose of this Commission was to furnish a single advisory group, representing all the professions concerned, to guide the division and its

1. Darell Boyd Harmon, "Some Preliminary Observations on the Developmental Problems of 160,000 Elementary School Children", *Medical Women's Journal*, March, 1942.

2. Later, more thorough and intensive tests and measurements showed the incidence of difficulties among the children ran considerably higher than indicated by the preliminary screening surveys.

collaborating agencies in planning, operating, and evaluating the activities carried on. The organization plan of the Commission is shown in Figure 1 on the following page.

During the first three years, an inventory was made of the physical and psychological difficulties afflicting Texas school children. Simultaneously, a check was made of classroom factors which might be related to those difficulties. These inventories took the form of screening surveys of the health and educational problems of some 160,000 elementary school children, and measurements of the physical aspects of over 4,000 classrooms in which these children were attending school. These surveys were made to secure tentative information for use in formulating plans for more intensive studies of the difficulties found, the causes of those difficulties, and means for their prevention.

In a preliminary report¹ on these surveys, the director said:

"Analysis of the data showed that at least 52 per cent of the elementary school children were leaving the elementary school with an average of 1.8 observable preventable defects per child.² The large overlapping of visual, postural, nutritional, (chronic) infection, and behavior difficulties, would seem to point to common factors in the causes of these defects. . . . Probably from four out of five, to nine out of ten of the observed difficulties have their origin during the elementary school period Inter-correlation of the defects observed with classroom factors would seem to indicate that the following, in order, are . . . contributing to the causes or severity of the defects: (1) *improper seating*, (2) *improper lighting*; (3) *improper placement of working materials*; (4) (etc.) Observations made on relations between the physical factors of the classroom and the difficulties in children would also tend to indicate that these deviations are caused or precipitated by the resultants of the various environmental forces affecting the child. . . ."

In discussing these environmental factors, the preliminary report of the director pointed out that, in a significant number of children, a relationship could be demonstrated between the combined forces of restraining seating equipment and improper distribution of light or other light deficiencies, and functional visual difficulties, postural defects, or other health problems from which the children were suffering. A similar relationship was demonstrable between either or both of these groupings and children's distortions of writing, drawing, and other educational performances.

TEXAS INTER-PROFESSIONAL COMMISSION ON CHILD DEVELOPMENT

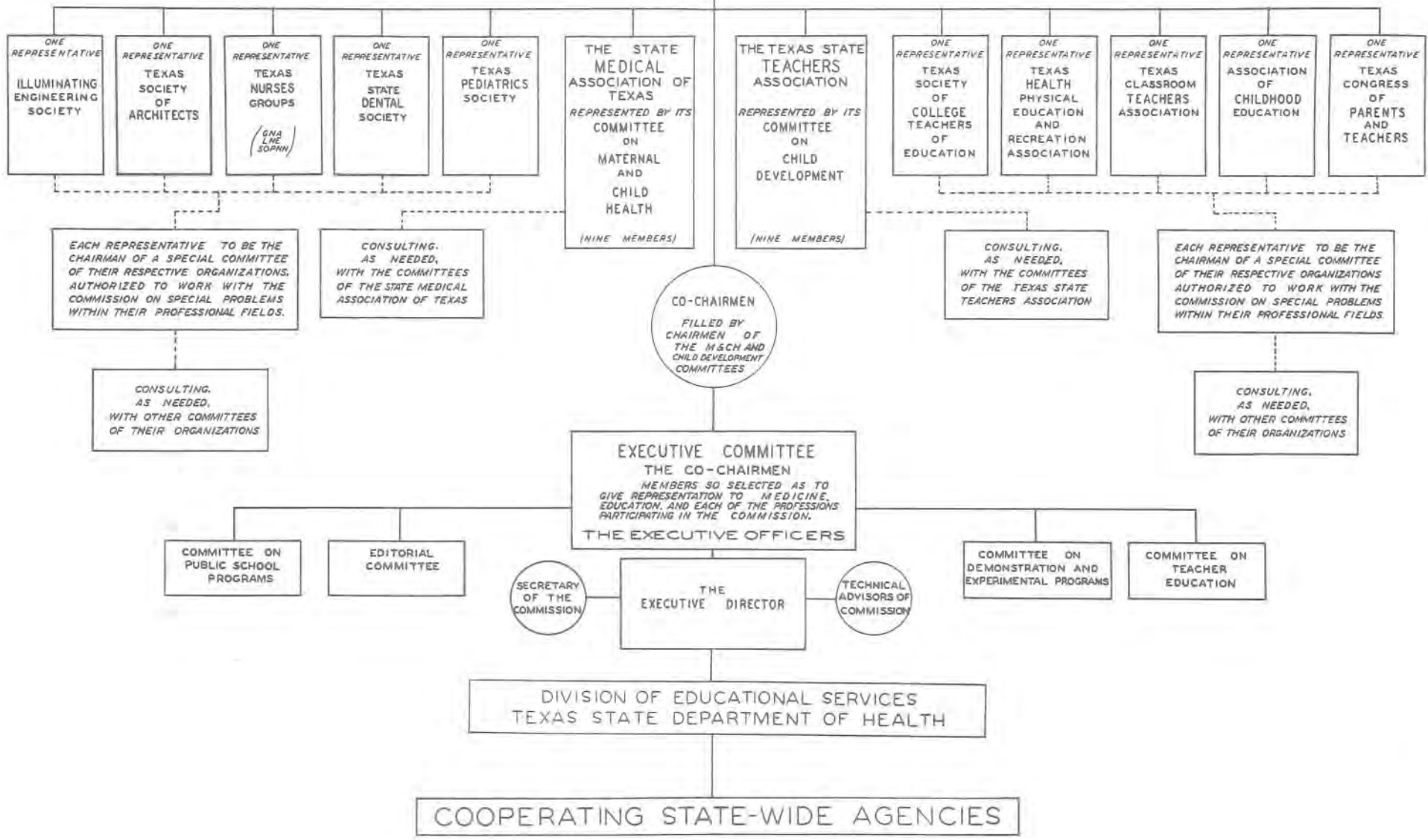

At the conclusion of these preliminary surveys, intensive studies were started in those areas which the surveys had showed might contain the major factors conditioning the health and educational problems observed in school children. Because of the significant place improper seating and lighting had occupied on the list of possible contributing causes of children's difficulties, the effects of light and classroom equipment on school children were given important places in these intensive studies.

Two factors shaped the direction the program took in studying classroom planning: A vast amount of research existed on the eye itself; and practical minimum standards for the intensity of light on working surfaces could be obtained by schools in a number of forms, including the "Recommended Practices for School Lighting"³ of the Illuminating Engineering Society. However, the initial data indicated that the difficulties school children were having were probably more related to the bodily activities aroused when the eye was stimulated by light, than they were to resolution per se, or merely to the intensity of light on children's work. Bodily activity in close visually-centered tasks, and the total distribution of light in the classroom were made the major areas of study.

Both educationists and other scientists concerned with human development have stressed that the human organism is a complex, vital *unity*. While the various characteristics of the human organism may be studied separately, as problems of pure research, all are interrelated and interdependent, and in practical application must be considered together — for functioning or changes in one characteristic influence all other characteristics.

Within certain limits, the human body is an organic mechanism fitted to survive by its capacity to adjust itself or its relationships to the environment in which it finds itself — to go into action to establish balances with the forces and restraints which surround it, such as gravity, light, sound, temperature, and the like. The organism accomplishes this by shifting its internal equilibria between various bodily systems and parts, and by modifying or adapting many of its structures, through repeated function, to fit the specific environmental factors which it encounters in its day to day existence.

Adaptation to certain portions of the stimulating forces or energies surrounding the organism (i.e., the spoken words in the total pattern of surrounding sound; the contrasts between type and page in the total organization of perceived light, etc.) is a large share of what is termed "learning". The organism's adjustments and adaptations, however, are not made merely to the socially purposeful portions of the energy distributions of light, sound, and the like, as they are represented by the teaching materials in a

3. Now available as "American Standard Practices for School Lighting", sponsored by the Illuminating Engineering Society and the American Institute of Architects, and approved by the American Standards Association.

planned learning situation. The organism seeks to adjust and adapt not only to these stimulating forces, as they are presented in its "educational experiences", but it also seeks to adjust and adapt to the total distributions of all forces and restraints surrounding it which are in its sensory range.

While a statement like the one which follows would be an over-simplification, for clarity it might be said that, *organically*, a child adjusts and adapts to the total pattern of energy distributions which set the human organism into action. *Psychologically* and *socially*, on the other hand, the child adjusts to the socially or emotionally defined meanings attributed to certain portions or limited organizations of those energy distributions. The organic child, for instance, adapts to light by reflexly seeking a centering or balance with the total organization of light distribution patterns in his visual field (its quantities, its brightness differences and contrasts, its colors, etc.), while socially and psychologically he attempts to find an economic and satisfying response that fits not only the feeling tone his organic adjustive activity has aroused in him, but also matches the socially defined meanings attributed to certain forms or objects that light has illuminated. Similar differentiations can be made regarding responses and adjustments to sound, temperature, motion and all the other energy modalities for which we have sense organs attuned.

For optimum growth, learning, and development the immature organism must be free in both available energy and direction of performance to find organically useful and satisfying balances with the purposeful or acculturizing forces or stimuli in its educationally organized experiences. Uncontrolled brightnesses, sound, or other forces, and restraints of normal body mechanics, existing in an educational environment can all elicit organic adjustive patterns and attitudes conflicting with the behavior patterns and performances sought through the curricularly directed forces or stimuli. To survive and grow in such a surround, the organism then must and does make compromise adjustments or adaptations to these two areas of conflicting stimulation — compromises which can use energy excessively, warp structure, or delimit or deviate the purposefully directed educational performances of the growing child.

The whole organism adjusts and adapts to all the stimuli in its total perceptible surround. This adjustment of internal balances and modification or adaptation of certain body structures (eyes, muscles, bones, body chemistry, neural pathways, etc.) to the total energy distributions in its environment can be beneficial to the individual only if all these stimulating forces, both "educationally" purposeful and "educationally" extraneous, are controlled and coordinated so as to permit the immature organism to function within its growth patterns, and so as to expedite the organism's functioning in relation to the socially or

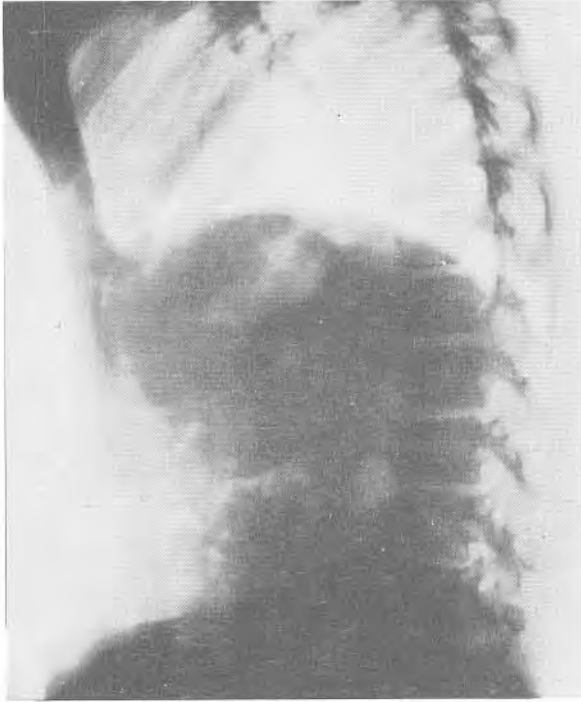

Figure 2
X-ray of spine of child in balanced posture. Note even distribution of pressure and forces at the intervertebral discs.



Figure 3
Child in balanced posture for close visually-centered activity.



Figure 4
X-ray of spine of child in traditionally "erect" posture. Note uneven distribution of pressure and forces at intervertebral discs.

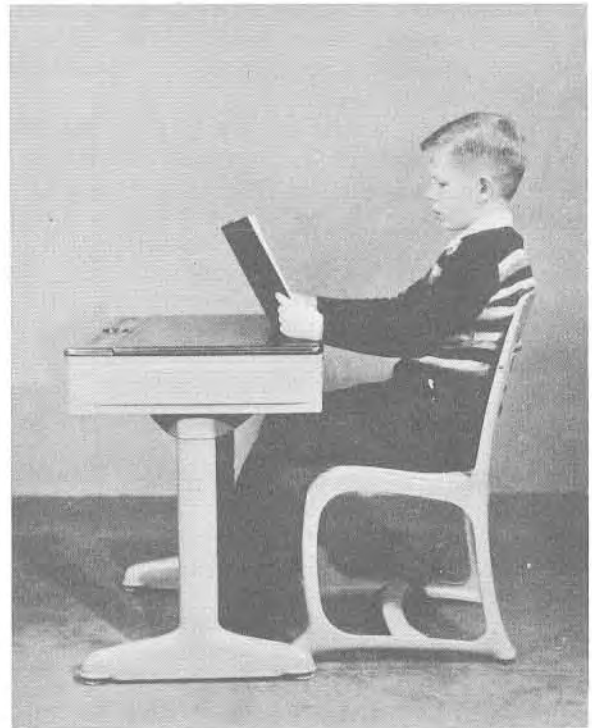

Figure 5
Child in traditional concept of "erect" posture for close work.

psychologically purposeful portions of those forces.

Whether the shift of body balances or the adaptations made are organically good or bad depends largely on the total pattern or arrangement of stimulating forces existing in a specific environment; the degree and duration of those forces; the relations between the various patterns of behavior each of the distributions of the various forces bring forth; and, the body's capacity to "take" the stresses these forces and conflicts of forces set up in the organism — that is, the body's capacity to shift its internal economy and modify its structures in order to find a balance with or utilize these external forces, without depriving itself of energies or structural efficiencies needed for other immediate or later uses.

Body-balancing activities in relation to distribution patterns of light, sound, and other stimulating or restraining factors in the individual's surround are mediated by complex reflex mechanisms beyond the organism's voluntary control. Many of these reflexes have common nervous pathways and utilize the same musculature in some portions of their organization. They can as a consequence, either reinforce or conflict with each other. Whether conflict or reinforcement is the result, depends upon how the various energies setting these pathways and muscles into action are distributed in the individual's surround, because the organism's efficiency of function will be determined by the relation the centers of action set up in the organism by these different stimulating energies bear to each other.

For example, certain muscles of the neck and trunk are set into action through a system of nervous pathways leading from the labyrinthine mechanism in order to adjust and hold the body in balanced relationship with gravitational systems of coordinates. Many of these same muscles, and extensive portions of the same nervous pathways are used also in balancing the body with centers of visual attention. In addition, a considerable part of the same muscular and nervous equipment is involved reflexly in supporting and counterbalancing manual activity and other bodily movements in such tasks as writing or construction manipulations. It does not require much imagination to visualize the adverse or damaging stresses and inefficient performances that could be set up when the systems of gravitational, visual, and manual co-ordinates differed excessively because of poor planning or co-ordination of lighting, seating, and other task

ACKNOWLEDGMENT

The author and publishers wish to acknowledge gratefully the assistance given them by Dr. L. V. Ragsdale, superintendent of Butterworth Hospital, Grand Rapids, Michigan, through having the hospital's department of Radiology direct and prepare the X-ray studies of the posture of the school child used for illustration here. They wish particularly to thank Dr. Robert J. McCandless, Director of that Department, for his advice and assistance in assuring that these X-ray studies showed adequately the stresses affecting the child as he performed the tasks assigned him.

4. — as, for example, the reflexes related to visual fixation inhibit the gravitational response of righting the head and the related response of righting the trunk when attention is centered on a visual task.

factors in the surround. When we see, further, that some of these reflex body-balancing mechanisms have the capacity to inhibit the final balancing function of other reflexes,⁴ we can see how additional interferences can be introduced into the organism's efforts to attain economic and useful equilibria.

As the centers or axes of action in performing a task get closer to the individual, the organic stresses produced by a number of these body-balancing reflex mechanisms are intensified. Whether formal or informal, today's curricula present most of their stimuli to learning activity through reading, writing, drawing, manual manipulation, and other tasks involving close visually-centered activities. At least 80 per cent of a child's time in school is devoted to such tasks — and these are the tasks where the actions of the body-balancing reflexes are at maximum intensification.

The nervous pathways and other bodily structures controlling and operating the reflex body-balancing mechanisms set into action during the performance of close visual-centered tasks have been described or identified in physiological literature. Few norms appear in this literature, however, that tell just how much or in what pattern a child's body can be expected to move when those reflexes are set into action by specific classroom tasks or lighting and seating situations.

The determination of these closely visually-centered performance norms, together with how much deviation from these norms could be tolerated, and classroom factors which could cause children to exceed those tolerances, were the first goals set in the Texas Studies of classrooms.

Organically, human beings have more factors alike than different. This is to be expected when we realize that growth, the mechanisms of activity, and other factors entering into physical existence are governed by orderly, natural laws. For practical purposes, as an example, the two eyes are matched optical systems. As such, they must function according to definable optical laws. If a sustained visual task requires simultaneous adjustment of both eyes to function at a certain focal distance for efficient fusion and resolution, then it follows that the supporting structures of the eyes (the head and body) must also adjust to support both the eyes at a distance from the task determined by that focal distance, and hold them there as long as the task is being performed. If the task is one also requiring manual manipulation, (i.e., writing, drawing, construction activities, or holding a book) then these supporting structures must not only maintain the eyes at the appropriate distance from the task, but they must also support and balance the arms and hands at distances permitting both successful eye-hand coordination and maximum efficiency and economy in continued manual manipulation. These

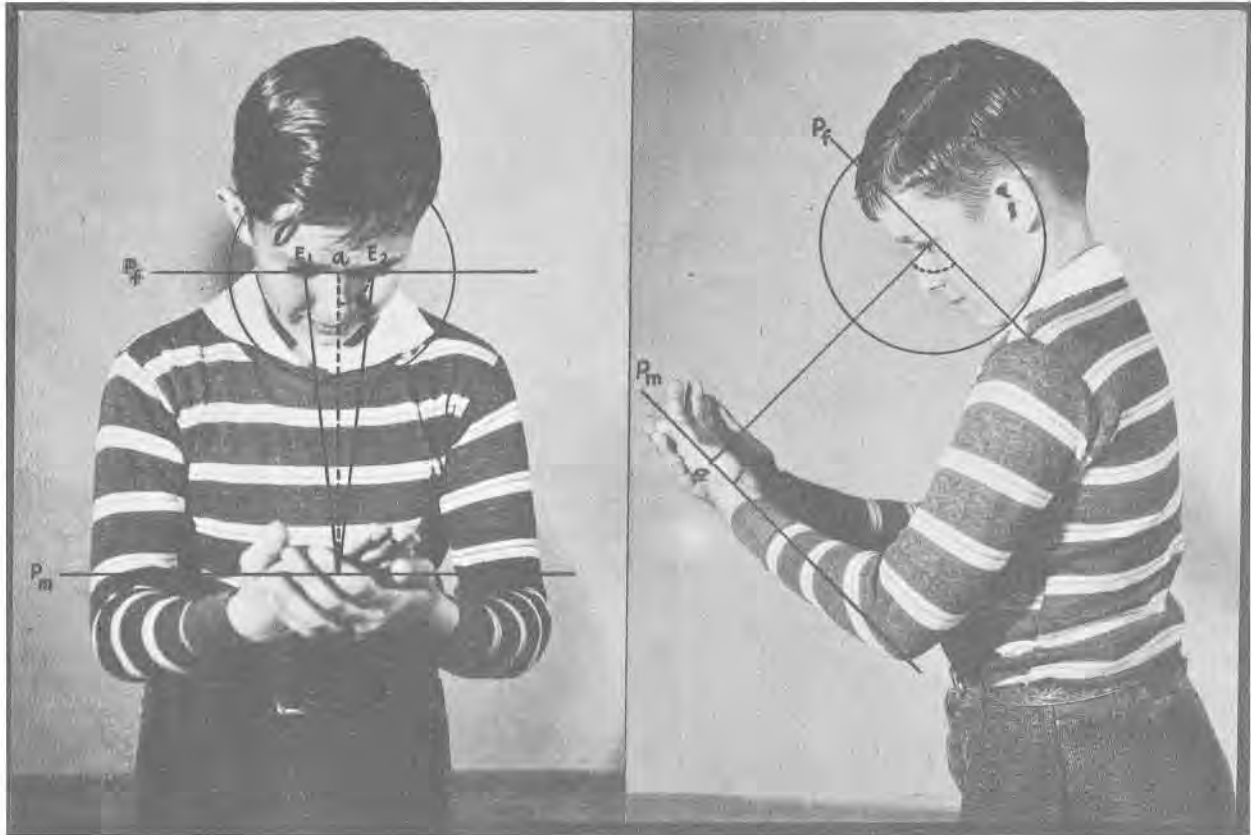

Figure 6

Child in balanced position for beginning close visually-centered activity. Overlaid diagrams present metric for this starting position.

activities must go on simultaneously with all the other activities which support the body against gravity, and balance it with all the other demands of the task, and with all the other effective stimuli in the environment. The common elements in body proportions, optical laws, and body function should and do reveal basic formulae for these light-stimulated close visually-centered activities applicable to all children that could be used both in planning classroom surroundings and for evaluating the efficiency of children functioning in them.

As part of these studies, measurements were made of the relations of the head, body, and eyes to the working area, and of the actions of the various organic systems involved, on several thousand children engaged in close visually-centered activities, such as reading, writing, and drawing. For comparison, similar measurements were made on adults. The director of the project reported:⁵

“(From these measurements) our data demonstrated certain *constant* relationships exist in the forward inclination of the head and trunk in sustained close visually-centered activities, as a result of the body-

balancing and orientation reflex mechanisms. When stimulated to such activity, both the trunk and the head lean forward out of the perpendicular to a position where they can be supported in this inclination with a minimum expenditure of energy and by means of minimum activity of the muscles supporting the weight of the head and trunk against the pull of gravity.” (Figure 3 shows a child in this balanced position, in contrast with Figure 5 the commonly accepted concept of balanced posture. Figures 2 and 4 are comparative X-ray sections of the child’s spine in each of these postures.)

Simultaneous with this forward movement of the head and trunk, the upper arms hang downward freely from the shoulders and the forearms move upward, with their extremities moving inward. These movements bring the forearms into a plane parallel with the plane of the face. If the elbows are resting on a horizontal plane when these movements are completed, the plane described by the forearms will tilt upward from the horizontal plane at approximately a 20° angle. In addition, if the hands are held open and extended palms upward, during these movements, when they overlap, the center joints of the middle fingers of each hand will intersect a vertical

5. Darell Boyd Harmon, “Illumination and Child Development”, a paper presented at the Annual Meeting Southwest Section, Illuminating Engineering Society, Ft. Worth, April 13, 1942.

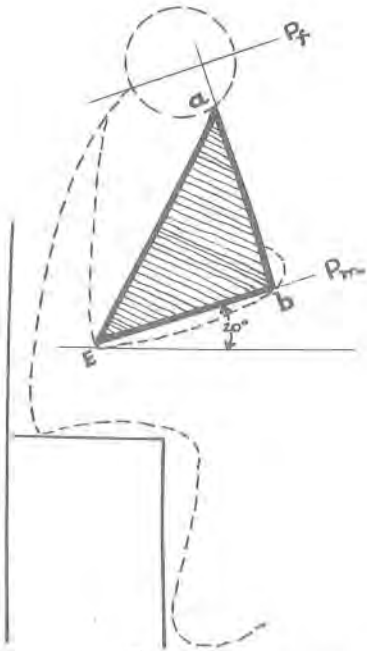

Figure 7

Schematic projection onto medial plane of the trunk of balanced postural relationships for close, sustained, visually-centered tasks.

plane extended forward into space from the midline of the trunk and head, (the medial plane of the body).

By means of these reflex movements, the subject reaches a posture for close visual activity where the mid-point between the eyes, the point of each elbow (the olecranon), and the knuckle of each middle finger, roughly describe an equilateral triangle with

its base inclined upward from the elbow out of the horizontal by approximately 20° . The base of this triangle extends from the olecranon forward of the trunk and inward to meet a forward projection of the medial plane of the trunk.

When the equilateral triangle described by the middle knuckle, the point of the elbow, and the mid-point between the eyes is projected onto a forward extension of the medial plane of the head and trunk (the plane described above), as shown in the diagram, Figure 7, the shape of this projection on this medial plane approaches a right triangle. The lower angle of this triangle points towards the center of gravity of the body when seated, and the perpendicular leg becomes the line of sight from the point between the two eyes to the point of fixation. The base of the triangle is tilted upward at approximately the 20° angle that follows the upward slope of the forearms.

The photographs and drawings in Figure 6 present a front and side view of a child's reflexly assumed posture when engaged in close visually-centered activity. The line "Pf" in these figures represents the plane of the face, while the line "Pm" represents the plane of the materials on which the child is fixating, such as a book or sheet of paper for writing. Line "Pm" represents the same plane, 20° out of the horizontal, that is established by the forearms when they reach a position parallel with the plane of the face. Point "a" is the mid-point between the two eyes, and point "b" is the point of fixation (the point at which the child is looking). These diagrams are repeated, schematically, in Figure 8 for simplification.

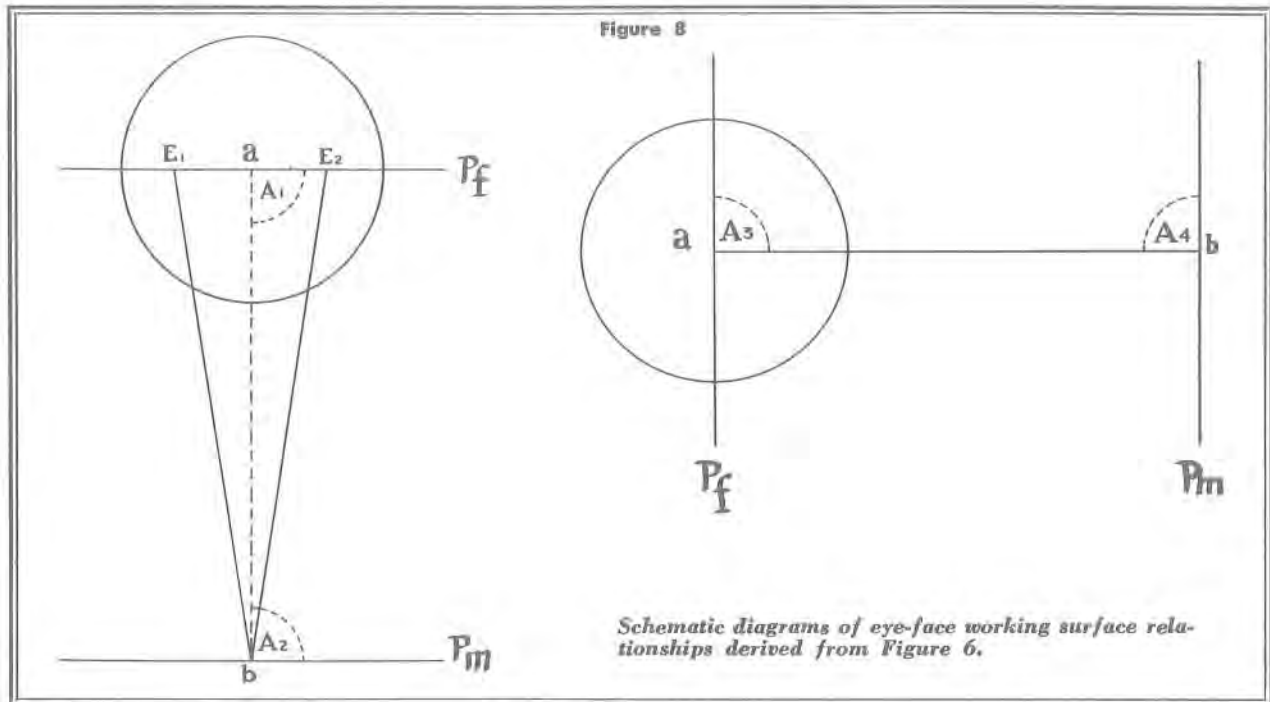

Figure 8

Schematic diagrams of eye-face working surface relationships derived from Figure 6.



Figure 10

Child in balanced posture, free to perform close visually-centered tasks. Lighting and working surface have been adjusted to meet child's needs.

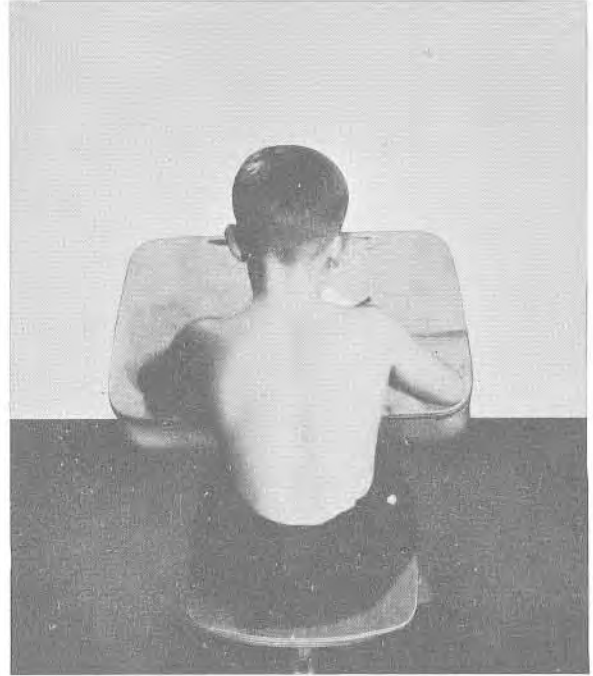

Figure 11

Back view of child working as in Figure 10. Note balanced posture, straightness of spine, and minimum of tension on back muscles.



Figure 12

Child in unbalanced posture, due to improper distribution of light. Notice tilt of head to protect eyes from high brightnesses out of working field. (Desk is properly adjusted, light is unbalanced in this test.)

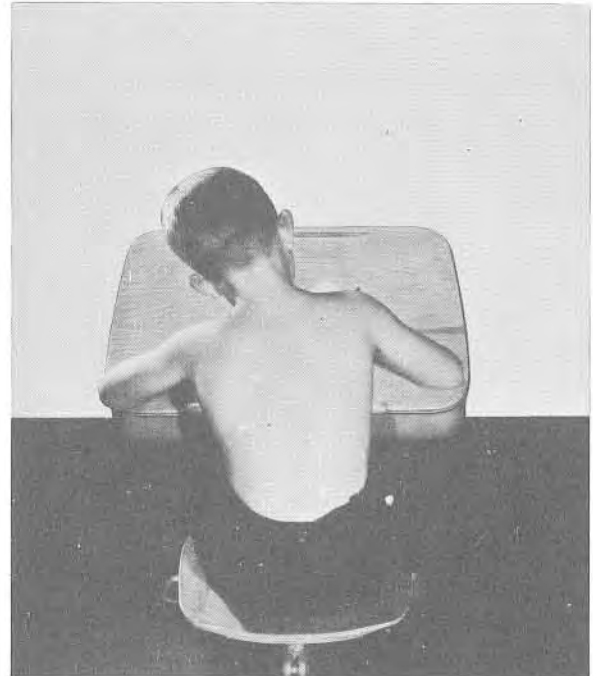

Figure 13

Back view of child working in unbalanced posture as in Figure 12, because lighting is out of balance. Note shoulder tilt, stresses on back muscles, and head tilt, all of which are out of the child's tolerances.

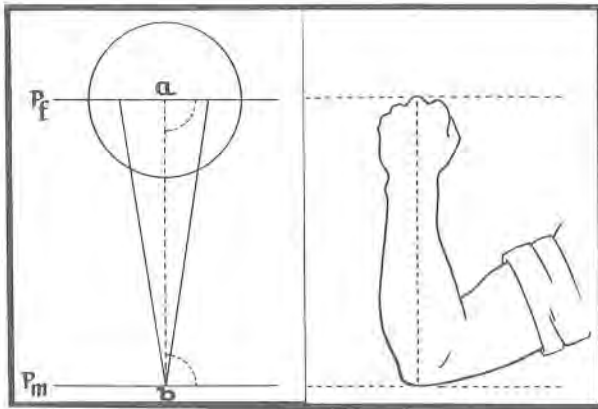

Figure 9

Method of determining working distance from intrapupillary point to point of fixation in close visually-centered activity.

The line "ab" establishes the upper and forward leg or edge of both the equilateral triangles formed by the mid-point of the eyes, the elbows, and the middle finger joint of each hand. For convenience hereafter, line "ab" will be called "the line of sight".

Points "E₁" and "E₂" in the horizontal drawing of the child represent the points where the frontal plane of the face intersects the two eyes. Notice that lines "Pf" and "Pm" are parallel in both views, and that the line of sight (line "ab") is perpendicular to both these lines or planes in each of these views. The angles marked A₁ and A₂ in the side view, and A₃ and A₄ in the horizontal view all approach right angles.

The position of the child's body represented in these three drawings is the starting position for close visually-centered activity. This is also the position to which the sight-related reflexes attempt to return the head, trunk, and arms all the time close visually-centered activity is going on. *Any other adjustive movements or other postures assumed during the course of the performance of the task (other than those for relieving normal fatigue) represent stresses or energy expenditures over and above those entering into this basic posture.*

The data showed that the visually dominated body-balancing and sighting reflexes operate to maintain the relations shown in these schematic drawings at as near constants as interfering factors in the environment will permit (such as interfering light, poorly fitted desks, etc.). These posture constants for efficient visual tasks were defined as follows⁶:

1. When free of restraint the plane of the face (Pf) in sustained tasks, at all times approaches a parallel relationship with the plane of the materials (Pm). The function of this action is to keep both eyes at as near the same distance from the work as possible, in order that both areas of retinal stimulation will be as near alike as binocular vision requires to produce a fused, single perceived image, and to provide that visual co-ordinates and postural co-ordinates approach each other as closely as possible.

⁶ Darell Boyd Harmon. "Lighting and Child Development", Illuminating Engineering, April, 1945.

2. The line of sight (ab) lies on a forward projection of the medial plane of the head (a plane extending from back to front through the head at the mid-line). If the child's fixation is only momentary, the line of sight is perpendicular only to the plane of the face. If the visual task is sustained, the head and trunk are reflexly adjusted (to reduce energy expenditure) so as to bring the mid-line or medial plane of the face into continuum with the mid-line or medial plane of the trunk. The line of sight then lies on a forward projection of a plane intersecting both the head and the trunk at their mid-line.

3. The line of sight (as measured from the mid-point between the eyes to the point of fixation) will be maintained at a length approximating the distance from the center of the third joint of the middle finger (middle knuckle) to the center of the elbow, when measured on the outside of the arm (the posterior linear measurement from the olecranon to the middle metacarpal). This measurement is shown in Figure 9. This is the distance from the eyes at which the two hands can work with them at the greatest efficiency. In some 40,000 measurements of subjects with normal vision, with few exceptions, the difference between this

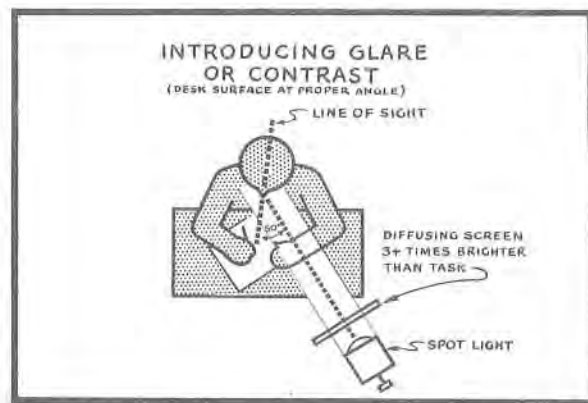

Figure 14

Method of setting up experiment shown in Figures 12 and 13.

measurement and measurements of the actual line of sight was not found to be over ± 3 centimeters. (± 1.181 inches).

4. Within certain limits, the line running between the two eyes (E₁E₂) on the plane of the face, and lines projected from the two eyes to the point of fixation (E₁b, and E₂b) form an isosceles triangle. The line of sight (ab) forms the perpendicular of this triangle. As the child's eyes move back and forth over the work he is seeing, this isosceles triangle is momentarily altered, but normally the movements producing these alterations will not be great enough to induce stresses, energy uses, or image distortions beyond the child's reserves or tolerances.

5. These linear eye movements (such as following a line of type) when kept within the child's physiological tolerances, and any posture shifts within these same tolerances which put the plane of the face out of parallel with the plane of the materials, do not pro-



Figure 15

Child in unbalanced posture, due to working on horizontal surface while engaged in "two-dimensional" activity. Notice excessively forward movement of trunk and head. (Lighting is properly adjusted, desk at incorrect working angle in this test.)



Figure 16

Back view of child working in unbalanced posture as in Figure 15, because desk surface is horizontal while he is performing "two-dimensional" close, visually-centered task. Back and shoulder stresses similar to those produced by improper lighting.

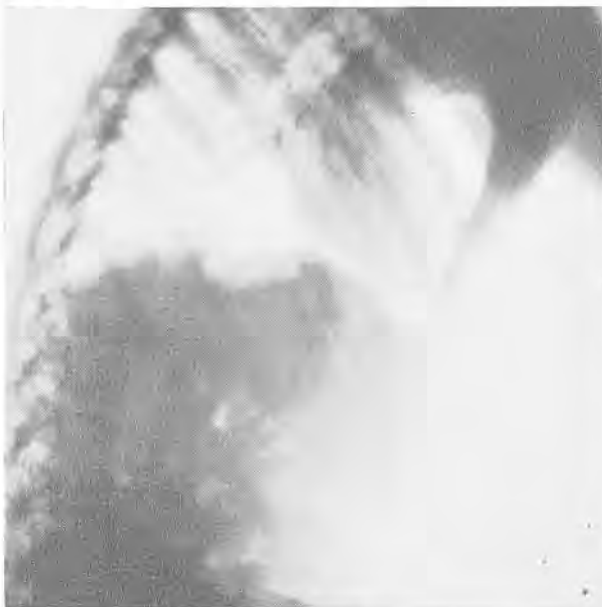

Figure 17

X-ray of spine of child working as in Figures 15 and 16. Note force and compression of intervertebral discs and disturbance of cantilevering of spine, preventing freedom of movement.

duce over $\pm 20^\circ$ changes in any of the right angles represented by A_1, A_2, A_3, A_4 — (the perpendicular relationships of the line of sight to both the plane of the face and the plane of the materials.)

6. When the child's tolerances are exceeded by altering these angles, or any combination of them, by an

amount greater than $\pm 20^\circ$, or when the length of the line "ab" is persistently altered from that expressed in 3, above, efficient physiological functioning is interfered with, visual images are distorted, energy is used excessively, or, damaging stresses are set up either in the eyes or the child's body.

As long as there is a motivation for the child to engage in a close visually-centered activity, the reflex connections between his eyes, neck, and trunk operate to attempt to maintain the above relationships. The front and back views of the child in Figures 10 and 11 were taken without posing, while he was engaged in writing, seated at a properly proportioned desk with the light properly distributed on his task and throughout his visual field. Note particularly that he is working off the mid-line of his body, his back is straight and free from restraining stress, and there are no tilts in his head or other postures exceeding the 20° of tolerance.

The front and back pictures in Figures 12 and 13 show the same child doing the same task at the same properly fitted desk. For this picture, however, the light was shifted on the child's left so as to produce glare and set up improper contrasts in his visual field, as shown in the diagram in Figure 14. Notice how he has reflexly shifted his head just far enough to exclude the glare (see the shadows around his eyes), but in doing this the relationship between his eyes, head and work exceed his tolerances. His back now is out of alignment, and there are accompanying excessive stresses set up in his back and arm muscles by this effort to balance his body with his work, with



Figure 18

Child in balanced posture for performing close-visually-centered "three-dimensional" tasks, such as modeling, building, using blocks, etc.

gravity, and with the erratic light forces in his visual field.

In addition to the effects of glare and adverse contrasts in shifting a child's body balances out of tolerance, a child's posture and performance efficiencies in close visually-centered activities can similarly be affected by the angle of inclination of the working surface. As was seen earlier, a child reflexly goes into action to attain three relationships (among others) in establishing a balance with a close visually-centered task presented on a plane (such as reading, writing, and drawing). One of these actions is the raising upward of the forearms which carries the plane of fixation or activity approximately 20° out of the horizontal. The other actions are the striving to bring the plane of the face parallel with the plane of fixation or work, and the effort to maintain the proper length of the line of sight. Reflex efforts to attain these relationships continue as long as the child is confronted by the task. Of these three action patterns, the dominating one is the effort to bring the plane of the face parallel with the plane of the working materials.

When the working surface is horizontal or inclined at an angle out of the horizontal of less than 20° (as is found in many schools where tables are used for desks, or where desk surfaces have the traditional 4° - 6° slope) the child is forced to lean forward as he pursues his task in his reflex efforts to bring the plane

of his face into a parallel relationship with the plane of task. Extra stress is thereby thrown on his back to support his trunk against the pull of gravity, thus limiting his freedom to perform his task. In addition an oblique thrust is set up in his trunk because he tends to support part of the weight of his trunk on an elbow in order to reduce some of the added gravitational stresses on his back muscles. With close visually-centered work placed on a horizontal surface, such as a table, both the forward movement of the trunk and the oblique thrusts set up as described above, carry the relationships of the child's eyes, head, trunk, and work well outside his various tolerances.

Figures 15 and 16 show the same child as shown in Figures 10 and 11. In Figures 15 and 16 he is working under proper lighting conditions but his desk surface has been shifted to a horizontal plane. Notice how he has reflexly leaned forward until defeated by the inner edge of the desk, in his effort to establish a parallel relationship between facial and work planes. Notice also the restraining tilt of his shoulders and the stress on his back created by the necessary shift of the support of his weight to his upper arms and elbows. The horizontal working surface has produced similar bodily mal-alignments and excessive stresses to those set up by glare and poor light distribution.

When the child is engaged in three-dimensional construction activities, such as modeling, building, using blocks, etc., different balancing co-ordinates are established than the co-ordinates set up for working on a plane, and additional reflexes are brought into action. While the child's trunk shifts to the same position as that assumed in reading, writing, and drawing, the principal plane on which he fixates visually in construction activities tends to approach the vertical. His arm position is also reflexly altered in three-dimensional activities. Writing and drawing are accomplished principally by a mass action of the total arm with the action centering around the shoulder. In construction activities, the actions are more discrete, centering in the wrists and elbows. To provide proper support and adequate freedom for these activities, the elbows are raised upward and outward until the forearms are approximately in the horizontal, but the hands are left in the same relationship to the trunk and at the same height as they were in the writing and drawing position. Both the shift of the plane of fixation from a 20° inclination off the horizontal to the vertical, and the shift of elbow and forearm positions necessitate a horizontal working surface for efficient performance and satisfactory body balance. The photograph in Figure 18 shows a child in proper position and balance for three-dimensional construction activities.

In construction activities, the child still attempts reflexly to maintain the same working distance from the point between his eyes to his point of fixation that he does in reading and writing. This is the distance needed for complete eye-hand co-ordination. As his fixation shifts from the base of his work upwards through the vertical plane of his task, the distance from his eyes to his task is reduced. His reflex efforts,

to adjust this working distance back to one inside his tolerances, are expressed by a thrust against his feet to move his trunk and head position forward or backward in space, as needed, by shifting the placement of the chair on which he is seated. Fixed-position seating can alter the functioning of these reflexes, setting up related excessive stresses and alterations of visual and performance efficiencies.

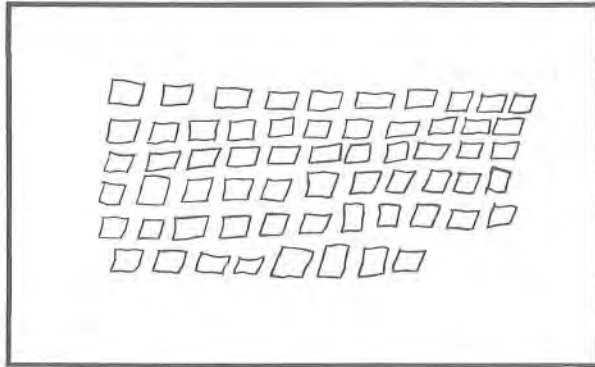

Figure 19

"Square" test for demonstrating postural imbalances produced by the child in Figure 20 while his photograph was taken.

Experimentation done previously by the director, and continued in the Texas program, showed that tests can be constructed for demonstrating graphically the relationships existing between a child's body-balancing mechanisms and his performances in close visually-centered activities, such as reading, writing, and drawing. It has been shown by psychologists, who have standardized mental tests, that children of the maturity of those entering school are capable of drawing free-hand squares with a limited amount of irregularity. The writer's study of squares drawn by children of school maturity showed that, when a line of squares is drawn approximating the size of the subject's handwriting, while the child is working in the correctly balanced postures and relationships, the deviations or irregularities in his squares or in their alignment will not exceed 20° in any axis. Subjects who exceed the tolerances for postures and other relationships that have been previously stated, will distort their squares or the alignment of their squares according to the laws of perspective, or the laws of optics, beyond their normal distortions by an amount mathematically approaching the amount they are exceeding their tolerances for postural and eye-head-trunk-task relationships. (This holds only for subjects with normal vision, and without serious structural or motor handicaps affecting posturing and performing mechanisms.)

This free-hand "square" test gives a quick way for graphically determining possible postural or environmental causes for reading errors, and drawing and handwriting irregularities or failures. The validity of this test can be demonstrated by an observer placing

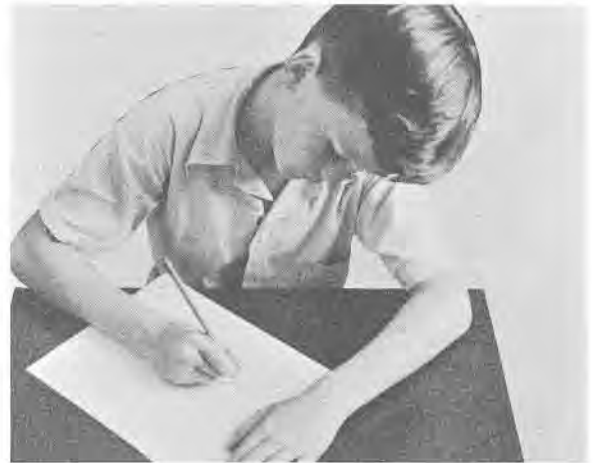

Figure 20

Child performing "square" test while in unbalanced position due to flat table and poorly distributed light.



Figure 21

Demonstration that child in Figure 20 is forced to suspend vision in left eye due to posture he assumes in close visually-centered tasks.

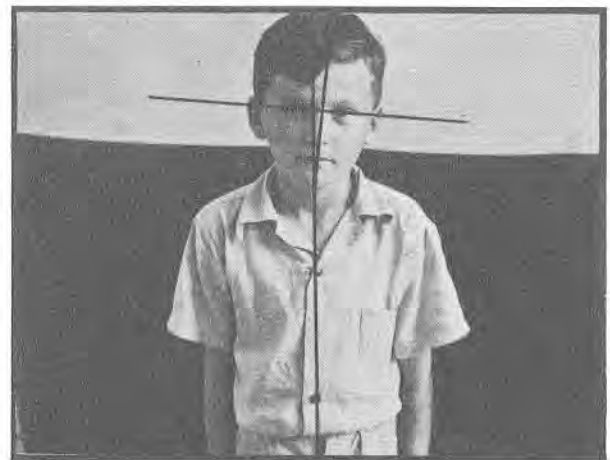

Figure 22

Demonstration of postural asymmetry, while standing, induced in child in Figure 20 because of unbalanced posture in performing school tasks.

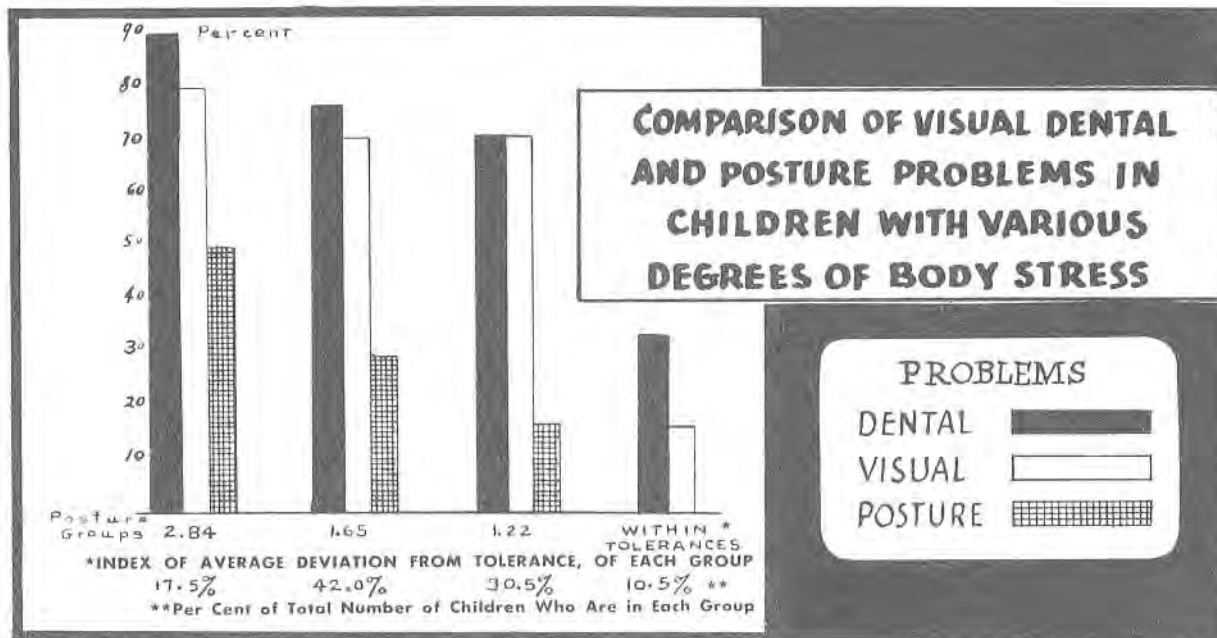

Figure 23

himself in the proper relationship to the squares drawn by the subject being studied. The plane of the observer's face should be parallel with the plane of the materials he is examining, and his line of sight should be perpendicular to these materials at the specific square he is studying. When he rotates a spherical, or a spherical and a cylindrical lens, against its axis in various directions while the lens intersects his line of sight, he will see the subject's drawing approach a form more nearly square. When the observer finds a lens position where the subject's drawing most nearly resembles a square, it will be noted that the axis or combined axes of the lens, or lenses, point along the line on which the subject sighted while making his drawing.

The lines of squares in Figure 19 is a photograph of the actual "square" test being given the child shown in Figure 20, while his picture was being made. The child was photographed while he was shifted out of a balanced posture both by working on a flat table, and by glare in his upper field of vision. To assume some form of supporting balance both with his work and with the posture needed to protect his eyes from glare, he has been forced to center his work to the right of the mid-line of his body. Note, in his "square" test, how he starts with a reasonably normal square, but distorts the perspective of his work to the right as he goes on across the line.

An established ophthalmological principle states that differences of intensity of illumination between the two eyes amounting to over 12 per cent leads to suspension of vision in one eye. When either of the angles A_1 or A_2 , shown in Figure 8, are changed from 90° by an amount greater than 20° , as would

happen in a working posture such as that assumed by the child in Figure 19, just as this angular change passes the 20° limit of tolerance it can be shown by an application of the appropriate laws of illumination that the light to one eye has then been reduced 12 per cent below the light to the other eye. (Based on the modal intrapupillary distance and modal working distance found in the children studied.) Angular changes greater than 20° reduce the illumination to one eye as compared to that of the other eye by an amount greater than 12 per cent. The suspension of vision in one eye due to this angular reduction of illumination can be demonstrated by attempting to stimulate a protective change of posture by passing a hand in front of the eye suspected of having been suspended in function. If no protective response, such as pulling the head back, is elicited, vision has been suspended. Figure 21 shows such a check being made on the child shown in Figure 20. Notice that he has not changed his posture from that in Figure 20, thereby demonstrating he is suspending vision in his left eye due to the apparent reduction of light to this eye caused by the postural shift forced on him by his adverse working surface and lighting surround.

Figure 22 shows what has happened to his body alignment as a result of these postural shifts imposed on him by his improper working surround. The line through his eyes should be at right angles to the line representing the medial plane of his trunk. He now carries his head tilted sideways, however as shown in Figure 21, as a result of cross-conditioning of his oblique extra-ocular muscular with the muscular of lateral movement of his eyes. This cross-conditioning took place because such a combination of the muscles of eye movement was necessary to follow the lines of



Figure 24



Figure 27

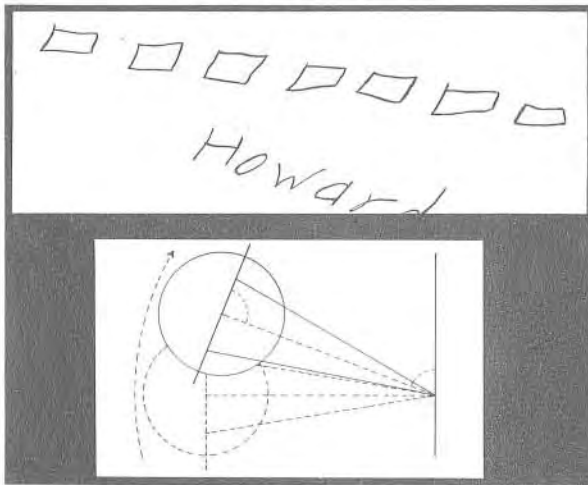

Figure 25

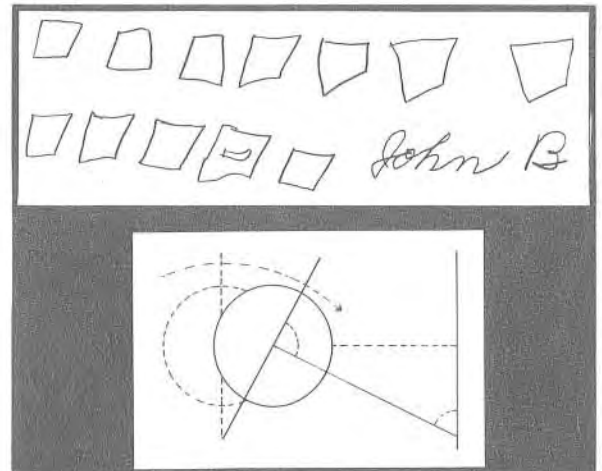

Figure 28



Figure 26



Figure 29

Two case records of performance on postural stresses, taken from Texas Studies, which demonstrate effect of improper seating and lighting in an unco-ordinated environment.

writing or print in his school task from the position into which his body and head were forced. This conditioned combination of eye movements necessary to follow lateral alignment, shifts his posture adversely, and becomes a handicap to him in performing visually-centered tasks other than those attempted in his characteristic placement in the classroom.⁷

If, in meeting a new or only partially assimilated experience, "a child reproduces what he senses," and "learns what he reproduces," as the laws of learning through activity seem to imply, it does not take much examination of these tests to begin to wonder what is happening to the visually-related learnings of many school children. When it is also recognized that the same environmental forces such as poorly designed desks, improperly distributed light, or, excessive brightness contrasts, which cause these performance deviations may also enter into shifting growth, and may consume excessively the energy needed for body-building, protection against infection, and for purposive performance, (and, in addition, can disturb other bodily equilibria which make for well-being), planning and maintaining a co-ordinated classroom environment in our school plants becomes a project of major importance.

How extensive the ramification of developmental problems related to postural stresses in school children can be is seen in Figure 23 in which even problems of dental malocclusion, as well as of vision, show a positive relationship with the deviations of balanced posture into which children are forced because of the inadequacies of their school seating and other factors in their classroom surround. Figure 23 is based on data from an unpublished study by Lillie Mae Finnegan, which she did at the University of Texas in 1945, under the direction of Dr. Hilda Rosene (physiology and biophysics) of the University's Department of Zoology.⁸ The data here are taken from Miss Finnegan's correlation of the problems of vision, dental malocclusion, and posture, found in a group of Dallas (Texas) school children, with the various degrees of deviation from the norms and tolerances for close-visually-centered activity, presented earlier, which they show while performing their school tasks. Note the very significant increase in the incidence of these health problems with each step of increasing stress as determined from their environmentally forced departures from balanced working-posture co-ordinates.

The photographs and drawings in Figures 24 through 29 present a more detailed pictorial analysis of typical stress problems induced in children by improper classroom equipment and lighting. These pictures were taken from two actual case records in the Texas Study. In each case the child had been seated

throughout the school year at a table with the working surface at a right angle to the window. The photographs were taken under conditions reproducing each child's classroom situation. Each child had been forced in his classroom to adjust to a flat table and to sky glare visible through the center portion of the classroom windows. Each had also attempted to come to balance with high brightness contrasts in his visual field, in which the greatest brightnesses are in the upper left of the field. These pictures were made after each child had been in this situation one school year. While each has found an individual "solution" (one by rotating sideways, the other by leaning forward excessively), the same protective pattern is evident in each case.

The diagrams accompanying these figures show the manner in which each child shifted from a balanced posture to assume a protective position. A double-exposed photograph of each child is shown while he was working at his desk doing a "square" test. This rapid double exposure shows the movement of each child from an initially balanced position to his typical classroom posture. These double exposures demonstrate quite graphically how much bodily stress is created in each child as he reflexly assumes his characteristic working position because the energy co-ordinates of his surround (in these cases the co-ordinates of light distribution) and the structural co-ordinates of his desk do not match the postural co-ordinates necessary for efficient and physiologically economic performance of his close visually-centered tasks.

Figures 25 and 28 include the "square" tests these children were doing while the photographs were being made. It is quite evident, in an inspection of the distortions of perspective and alignment of these drawings of "squares", that the children's work is being directly affected by their unbalanced optical and motor approach to their tasks.

The additional photographs in these figures show each child standing erect, fixating on a target at his eye level. It is apparent from these pictures that their working postures have induced stresses in their bodies out of alignment with their growth patterns, and these, in turn, have affected their growth by altering the balance between the lateral, and between the medial halves of their bodies.

These performance and growth patterns, taken from actual case records, are apparently reproduced innumerable times, in various forms, by the unsound seating and lighting and the unco-ordinated surround in typical classrooms. The photograph in Figure 30 was made in an average classroom in the group of classrooms studied. It pictures a west room, and it was made while the sun was directly overhead on a clear February day. No direct sun was coming into the classroom, so the glare evident at the windows was due entirely to the sky. Notice how almost all the children in this room have been forced out of balance in their reflex efforts to exclude this glare from their eyes, and also to adjust to the contrasting bright and dark areas in the front of the room and on their dark desks, in

7. This is also a characteristic posture of those with astigmatism (and occasionally in those with vertical imbalances). Considering the torque created by the cross-conditioned musculature, the situation described here might be a causal factor in some of the astigmatism found in school children.

8. Lillie Mae Finnegan, "Relation of Certain Biomechanical Factors of Writing Activity to Visual Performance and Occlusion", Unpublished Thesis, University of Texas, 1945. This Thesis problem was suggested to Miss Finnegan by the writer in order to secure an independent check on some of the writer's findings in The Texas Study.



Figure 30

Average classroom in Texas Study. Note the number of children showing bodily stresses of various kinds due to sky glare, high contrasts within the room, improper decoration, and, badly designed desks and seats.



Figure 31

Front view of child in third seat from rear in window row of above classroom, chosen by chance, to demonstrate resemblance between stresses and unbalanced postures in average room and those presented earlier.

order to give some attention to their school tasks. Notice also how their adjustments are further distorted by badly designed desks and seating equipment. Backs are under stress, heads and bodies are out of balance, proper eye-task relationships are disturbed, and energy that at least should go into their work, is being consumed to protect them from some of the ad-



Figure 32

verse factors of their classroom surround. Back view of child shown in Figure 31. Note that he has tilted his head just sufficiently to eliminate the sky from his field of vision, and, he has been forced to lean forward because of low angle of desk top.

verse factors of their classroom surround.

The two photographs in Figures 31 and 32 are front-and-back views of a child seated in the third seat from the rear in the row next to the window of the classroom picture shown in Figure 30. It is quite evident that his working relationships belong to the same type of distortions as those presented previously.

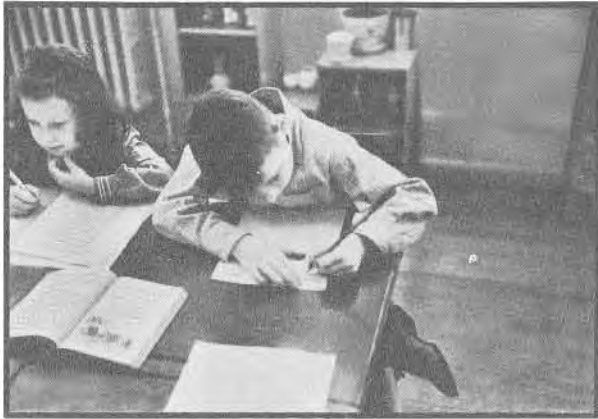

Figure 33



Figure 34

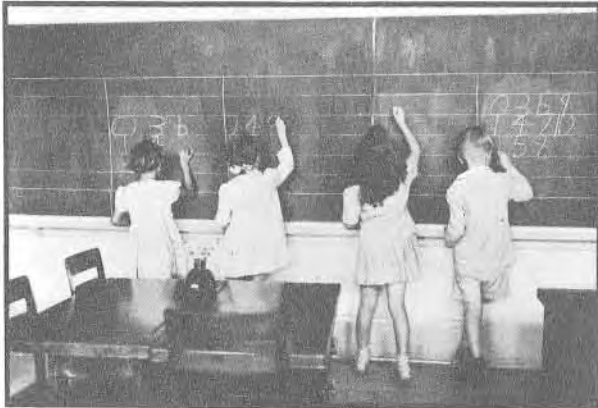

Figure 35

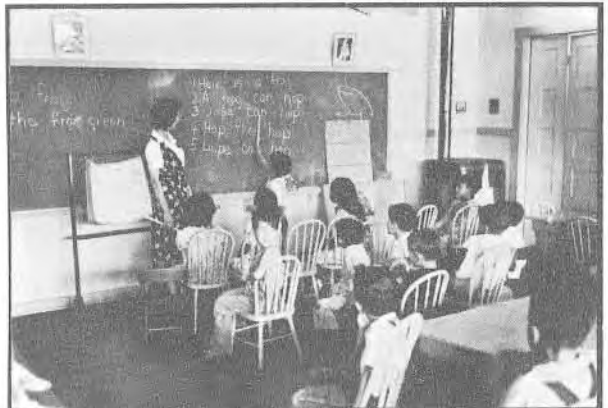

Figure 36



Figure 37



Figure 38

Some typical classroom situations showing body and visual stresses due to improper choice of seating, inadequate lighting, faulty chalkboard placement, and unsound decoration.

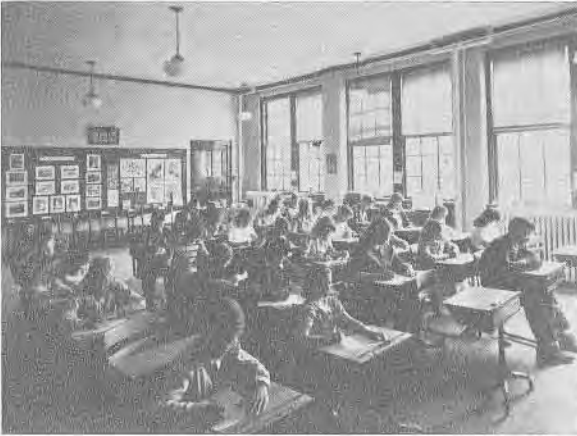

Figure 39

Seating rearranged, but sky glare, brightness differences, and seating design unchanged. Note general tendency in posture to protect eyes from sky glare.

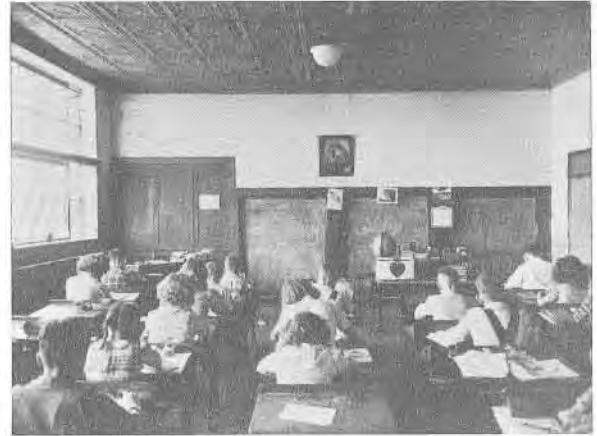

Figure 40

Wholly unco-ordinated room. Note excessive back stress due to improper decoration, high contrast, and poorly designed and arranged seating.

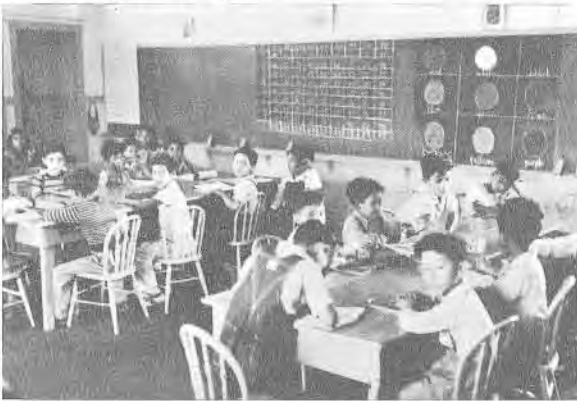

Figure 41

Adverse use of flat-top tables. Note how improperly selected seating and horizontal working surface place task so reflex body-balancing mechanisms are defeated. (Shown by children, with elevated shoulders, "reaching" for center of task.)



Figure 42

Good decoration pattern, but room lacks daylight control and proper choice of seating for sustained visual task. Note general tendency to rotate to right because of improper seating, reinforced by need to protect eyes from adverse sky glare.



Figure 43

Planned co-ordination of daylight, artificial light, and decoration, defeated by incorrect selection of furniture for sustained close-visual activities required in room. Note some unbalanced postures due to this furniture-selection error.



Figure 44

Merely rotating seats to protect from sky glare does not solve problem of unco-ordinated environment. Note how children are excluding high decoration contrast from visual field, both in vertical and horizontal, and are being defeated in finding balance by improper desk design for task.

The organic child has just so much energy to expend. This energy must go towards satisfying his basic needs in staying alive; converting his food into usable chemical forms; protecting him against infection and other disease threats; growing; and furnishing the energy for all the activities and adjustments demanded by his environment. Only a limited amount of his energies is really free for activity. When environmental-demands exceed the energy free and available for meeting them, the environmental-demand is met by depriving some other vital need of its energy. Growth suffers first in most cases. Continued stresses induced by poorly designed furniture, by poor distribution of light, or by visual performance demands inconsistent with basic visual performance patterns, might readily use energy needed for growth, for body function, for protection against infection, or for overcoming other adverse factors in a child's total surroundings.

Bodily growth is inherently a balanced process. But a study of growth shows that its centers, at any given time, are always at the center of the greatest bodily activity. In other words, the child's body, or bodily systems, tend to grow along the lines of stress induced by various activities, in order to reduce those stresses. If the environment sets up centers or lines of stress not fitting the alignment of inherent and normal growth forms, the result is structural warping. As the child continues to grow and function in such surroundings, the final result is asymmetrical or unbalanced body structures, deviating performances, or physical or psychological lesions and disabilities.

Part Two

AN INTENSIVE STUDY OF THE EFFECT OF THE CLASSROOM ENVIRONMENT

Following the preliminary surveys and determination of patterns of functioning in close visually-centered activities, the Texas group, in March, 1942, started a series of intensive field studies and experiments to develop principles and basic methods for controlling the adverse physical factors in the classroom environment. A number of experimental and demonstration centers were arranged in representative school systems and buildings. These centers consisted of elementary schools located in both urban and rural areas that had enrolments providing a statistical cross-section of the health and developmental problems of Texas children found in the preliminary surveys. Five school buildings were used at the start, with 1,764 children enrolled in the first five grades — grade levels to which the initial work was confined. Later, the number of experimental centers were increased, until, during the course of studying various aspects of the problems, as many as twenty-five plants

at a time were used as experimental or demonstration centers.

Children enrolled in these schools were given thorough pediatrics, dental, and psychological examinations; anthropometric measurements were made; nutritional, visual, educational, and other tests were administered; medical, dietary, and social histories were collected; and the physical characteristics of the classrooms were studied in detail.

The examiners enumerated, as a problem of well-being, any condition which existed in a child regardless of the degree of severity, whenever such a problem could be demonstrated to be affecting the child's school performances by reducing those performances below measurable inherent capacities to perform. In addition, factors indicating retarded or deviating growth and development, and functional as well as organic difficulties, were recorded as problems if they could be detected by accepted diagnostic means, and if they seemed to be affecting the child's school performance. Arrangements were made to repeat the examinations and tests given the children with sufficient frequency to determine, as accurately as possible, the children's changing health or developmental status as experimentation with classroom modification progressed.

The initial examinations and tests showed the incidence of difficulties, organic and functional, clinical and subclinical, which follows:

Visual Difficulties	53.3%
Nutritional Difficulties	71.3%
Postural Difficulties	30.2%
Possible Signs of Chronic Infection	75.2%
Possible Chronic Fatigue	20.9%
Dental Difficulties	92.0%

The number of difficulties found was not significantly different from the incidence of similar difficulties which had been found in groups of elementary school children elsewhere.

The physical conditions and arrangements of the classrooms in which these children were attending school also were found not to vary greatly from what has been reported by others as "typical" schools, although the types of buildings used for the demonstration and experimental programs varied from recently erected ones, built under careful and modern architectural supervision, to buildings that had been in use for as long as thirty years.

All the classrooms were lighted by windows on one side of the room only, and all satisfied the Texas school-building code in all aspects, including having the glass area in the windows equal at least 16 per cent of the floor area. Two of the urban buildings used for experimental purposes had classroom windows with glass area slightly greater than 25 per cent of the floor area, while the remainder ranged from the minimum requirements of the state code up to 25 per cent of the floor area. The average size of the rooms studied was 22' x 30' x 12'. Artificial lighting ranged from rooms fitted with two ceiling-mounted enclosing globes each covering a 100-watt lamp, to rooms



Figure 45

A control room used in experimental studies of rehabilitation requirements for old school.

equipped with six 500-watt luminous indirect incandescent luminaires.

Tans, buffs, and greens predominated in the wall colors used in these classrooms, while off-whites and or light colors were used on ceilings. Blackboards were mounted on front, inside, and rear walls of all of the rooms. With few exceptions, the classroom furniture was dark in color, principally finished in "school brown". Individual movable or fixed seats were provided for the children in most intermediate grade rooms, while most of the primary rooms were equipped with chairs and tables, seating from two to eight children. Seating was arranged in formal rows, paralleling the window walls. Maintenance reflectances of the walls (the portion of the light striking them that is reflected back by walls in the condition in which they were kept from day to day) ranged from 35 per cent to 50 per cent. Similar reflectance of ceilings ranged from 20 per cent to 70 per cent; for floors, 12 per cent to 18 per cent; for woodwork, 18 per cent to 24 per cent; and, for furniture, 12 per cent to 15 per cent.

For experimental purposes in testing methods of classroom lighting, decoration, and the selection and arrangement of equipment, the classrooms were arranged in pairs by using adjacent rooms or matched buildings. Each pair had the same exposure to daylight, and had the same general physical characteristics. One room of each pair was retained in its original condition, and the other was used for experimentation. The children in these rooms were matched as nearly as it was possible to match them.

A pair of these test classrooms are shown on Figures 45 and 46. The room pictured in Figure 45 is the unchanged control room, and the room shown in Figure 46 is its companion experimental room. The photographs of the experimental room show some of the basic changes that were made in improving daylighting decoration and seating arrangement in minimum programs of classroom renovation. For record-

9. R. L. Biesele, Jr., W. E. Folsom, and V. J. Graham, "Control of Natural Light in Classrooms", *Illuminating Engineering*, September, 1945.



Figure 46

Matched experimental room, paired with room in Figure 45, used in studies of rehabilitation of old school.

ing purposes, both these rooms were photographed at the same time on a clear February day while the sun was overhead and not visible in the rooms. These rooms have west exposures, and are located on the second floor with their exposure to the sky unobstructed by either foliage or buildings.

At the time the photographs were taken, the unchanged room had light on the children's working surfaces varying from 62 footcandles at the seat in the middle of the row nearest the windows, to 12 footcandles on the rear desk of the inside row — a diversity of five to one.

The horizontal light varied from 180 footcandles at the window sill, to nine footcandles at the inside chalkrail. Each child had many times more light striking his eye at the 45° angle from his line of sight than he had on his working surface. This crude index of glare showed ratios existing between light striking a child's eye at this angle, with the light on his work running as high as 7.5 to 1.

Simultaneous light measurements were also made in its paired room, Figure 46. The measurements in the improved room showed that, in all desk positions, the intensity of light on working surfaces was equal to and generally greater than that falling on the children's eyes. The light on working surfaces ranged from 130 footcandles, at a seat near the windows, to 55 footcandles on a desk in the inside row — a diversity of less than three to one.

These rooms were two of eight rooms used in an experimental building over twenty-five years old that had been selected for studying the minimum essentials needed in renovating old classrooms. The activities in this building were confined to studying procedures for controlling natural light, reflectance patterns for painting walls, and methods for advantageous arrangement of old-type, screwed-down desks. An independent engineering evaluation of the lighting results obtained through the experimentation done in this building was made by three illuminating engineers, at the invitation of the director of the project. Their findings have been published elsewhere.⁹ In the conclusions of their report these engineers said:

"The studies reported . . . led to several definite conclusions.
"(1) It is possible, inexpensively, to produce material improvement in the environment of the typical classroom by effective control of natural light.

"(2) This control can be accomplished in three major ways:
"a. Proper balancing of brightnesses in the field of view together with a general increase in the amount of illumination on the seeing tasks by painting walls and ceilings with a co-ordinated set of high reflection-factor, flat interior finishes.

"b. Maximum utilization of the highly directional character of the light entering the windows, by proper orientation and adjustment of desks.

"c. Proper window treatment, particularly the use of the diffuser as described in this paper, to obtain maximum benefit from direct sunlight (daylight) entering the windows, without at the same time permitting excessive brightness or brightness ratios in the field of view.

"(3) The control methods, as outlined, can be applied as readily to existing classrooms in old buildings, as to new school construction."

In an earlier part of their evaluation report, the engineers state: "The impression given by the remodelled rooms, particularly . . . with the diffuser, is exceedingly pleasant. There is a pleasant abundance of soft, diffused light, coupled with light surroundings, which produce a very comfortable visual atmosphere. The children appear less tense, and more attentive, and the teachers report the children to be more manageable than before the changes were made. There is a high preference for the new surroundings on the part of both teachers and pupils."

As the studies progressed, additional buildings were used for related projects concerned with determining the effects of various physical factors in the classroom on the well-being and performance of children. These ranged through studies of the effects of different light distribution patterns and other lighting characteristics; the selection of colors for wall decoration as well as the determination of necessary reflectances; refinements of principles and methods for daylight control; evaluation of methods for artificial lighting; functions, colors, and reflectance of chalkboards; orientation of working equipment; and basic principles of design for seating and working surfaces to permit full and free performance of various types of school tasks.¹⁰

From July, 1946, through August, 1947, the findings of all the studies were consolidated and introduced into the planning of an advanced experimental center in the Rosedale school, at Austin, Texas. Rosedale, built by the Austin Public Schools in 1939, was one of two buildings erected in the same general neighborhood, from the same set of plans, and equipped in the same manner. They were modern-designed, eight-classroom buildings, each housing the first four grades of school. Both were under the same supervising principal and both used the same course of study. Rosedale was selected for the experimental changes and the other, the Brykerwoods school, was selected as the control.

10. In addition to references in previous footnotes, other reports on these various studies have appeared in the technical literature from time to time. Two of these have been:

- (a) Darrell Boyd Harmon, "Light on Growing Children", *Architectural Record*, February, 1946.
- (b) Section "LIGHT . . . eye and body benefit together", Page 121, *The Architectural Forum*, November, 1948.



Figure 47

An experimental room, Rosedale School, used to study co-ordination of daylight control, artificial lighting, decoration, seating design and chalkboard selection.

In the Rosedale school, an attempt was made to co-ordinate the findings in daylight control, artificial lighting, seating and seating arrangement, and room decoration to produce a unified working environment for the children that would permit maximum freedom of performance of their school tasks at minimum physiologic expense. This was done by planning control of quality and distributions of the significant stimulating energies in each classroom (such as light, both natural and artificial) so that the responses elicited in the children as they sought a balance with these forces would center, and be in keeping with the centerings and responses the children made to gravitational requirements and to their purposeful tasks in all the orientations required by the curriculum. The seating and other working equipment was similarly planned to permit full freedom of response, both to the above stimuli and to the reflex actions set up to satisfy the child's basic organic needs in performing close visually-centered tasks. In addition, the total visual environment was arranged to define all of its aspects of form, size, location, relationships, texture, etc., in a manner visually equivalent to the children's acquaintance with them through their other sensory modalities. The latter was undertaken because of a growing recognition that much of adequate learning is multi-sensory — the product of an association and synthesis of compatible impressions and reactions to the world around the child gained through all possible means of experience.

Four rooms of Rosedale school were reconstructed as if they were new structures, and four rooms were handled as a problem in classroom renovation. The outer walls of the rooms to be modified as new structure were ripped out, and new fenestration was installed which included light-directional glass block above a hooded vision strip. Special paints were mixed to provide the colors, surfaces, and reflectances that previous experience had shown were desirable for classroom use. Furniture was designed and constructed for one of these test rooms to meet the specifications for function and finish of equipment that had

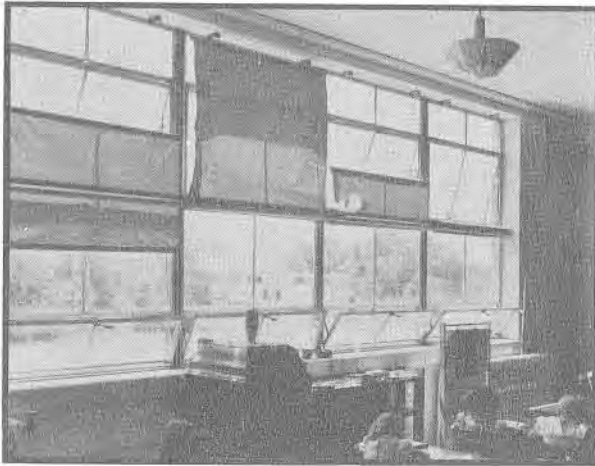

Figure 48

A view of high window contrasts in a room, typical of Rosedale School rooms, before experimental changes.

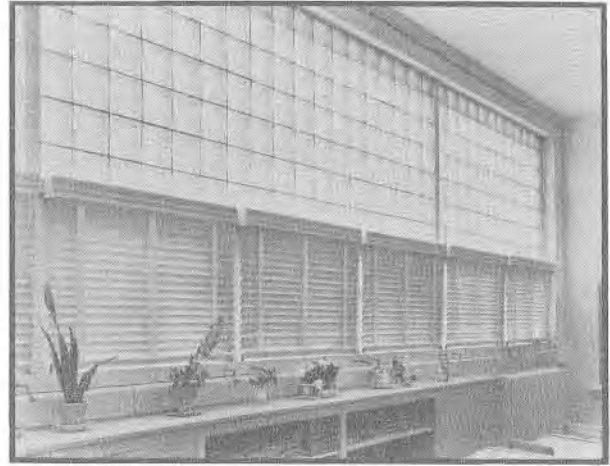

Figure 51

Window view of a Rosedale experimental room after change. Quantity distribution of outdoor light same as in Figure 48.



Figure 49

View to front of room shown in Figure 48, showing type of equipment and the light distribution in Rosedale School before change.

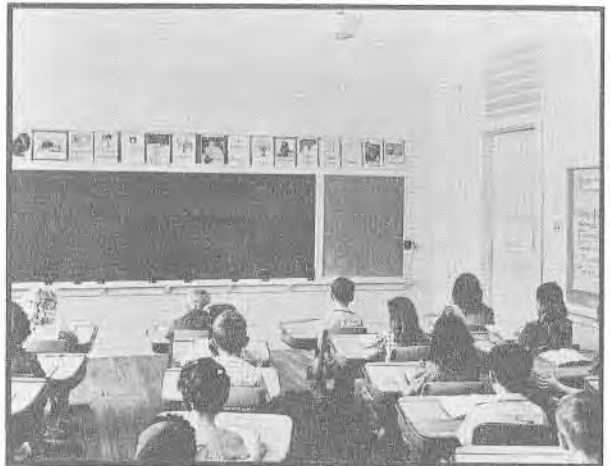

Figure 52

Front view of experimental room shown in Figure 51, with one of the patterns of co-ordination of equipment used in this school.



Figure 50

View to rear of typical Rosedale room before change. Note postural stresses and uneven distribution of light on faces.



Figure 53

View to rear of experimental room after change. Note freedom from postural stresses, and lack of reflected glare on faces.



Figure 54

Demonstration co-ordinated classroom in John Simpson Junior High School, Mansfield, Ohio, showing brightness readings in footcandle. With exception of brightness ratios of floor to task (floor was not changed), brightness ratios in this room meet or are better than recommended in American Standard Practice for School Lighting, and Guide for Planning School Plants of the National Council on Schoolhouse Construction.



Figure 55

Window-wall view of the Mansfield, Ohio, room shown in Figure 54.

been worked out for close visually-centered activity, and for the other rooms furniture of standard design, but meeting the same specifications for finish, was obtained. Selection of this standard equipment was

made to meet the needs in keeping with the curricular activities to be carried out in each room. Artificial lighting equipment was installed in each room according to specifications for both quantity and quality of lighting thought desirable as a result of previous studies. Both fluorescent and incandescent installations were made and a different type of equipment was used in each room. Chalkboards meeting the standards for color and reflectance set up by earlier tests were installed, and all the factors in each room were checked and adjusted to bring them into what had been planned to be adequate co-ordination.

A similar program was undertaken in the rooms treated as problems of renovation of existing classrooms. Specially designed light diffusers were attached to the existing windows in these rooms to control the natural light, instead of installing glass block. Existing blackboards were retained, and the furniture was rearranged and some of it refinished, rather than being replaced by new equipment. The decoration program was the same as that undertaken in the re-built rooms. Artificial lighting was changed to meet

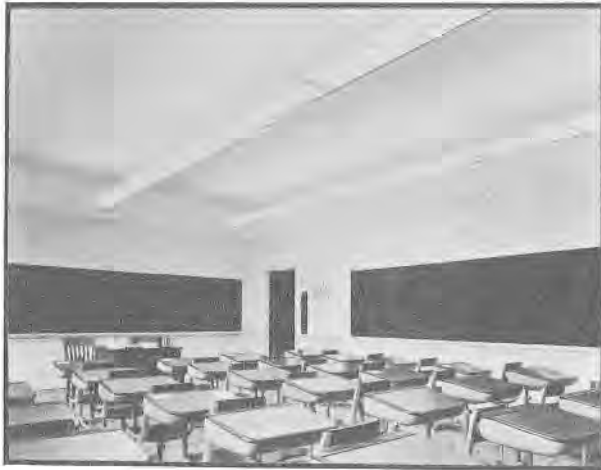

Figure 56

View of second experimental room in the John Simpson Junior High School, Mansfield, Ohio. Blackboard and dark furniture were retained in this room. Note adverse optical effect as compared with Figure 54, due to high contrast created by these dark surfaces.

the same specifications for incandescent and fluorescent equipment as used in the rooms treated as if they were new construction.

Not all the objectives have as yet been met, as they were set up for the experimentation in Rosedale school. However, some of the results were summed up in a statement made in an independent engineering evaluation report, filed with the director of the project and with the Austin School Board, which said:¹¹

"The remodelled rooms, as indicated by these studies, are probably the closest approach yet made to an ideal classroom environment. The co-ordination of daylight controls at the windows with room decoration, seating, and seating arrangement produce a visual environment which is remarkably constant for wide variations in the natural lighting conditions. The artificial lighting systems also co-ordinate well with the rest of the room treatment, and in general produce a similarly beneficial environment."

Descriptions and illustrations of the Rosedale classrooms have been published elsewhere.¹² Photographs of two of the completely changed rooms, together with charts of brightness measurements of these rooms under artificial lighting, and one picture of the diffuser installation in a renovated room, appear in the current "American Standard Practice for School Lighting".¹³ Figure 47 shows a remodeled Rosedale room equipped

11. R. L. Biesele, Jr., and W. E. Folsom, Registered Professional Engineers, Dallas, Texas, Report on "Illumination Tests of the Rosedale School, Austin, Texas", filed, August 15, 1947.

12. Among these have been: (a) Mildred Whitcomb, "Classroom Lighting" *The Nation's Schools*, May, 1947.

(b) M. F. Baldwin, "Adequate Schoolroom Lighting", *Southwest Electrical Industry*, February, 1948.

(c) W. E. Folsom and R. L. Biesele, Jr., "The Measurement of Illumination in a Classroom", *Illuminating Engineering*, April, 1948.

(d) T. D. Wakefield, "Brighten the Corners", *The School Executive*, November, 1948.

13. Illuminating Engineering Society and American Institute of Architects, "American Standard Practice for School Lighting", approved Sept. 20, 1948, by American Standard Association, Published by Illuminating Engineering Society (Pages 15, 16, and 25).



Figure 57

Exterior view of the St. Theresa Parochial School, Houston, Texas, Golemon & Rolfe, Architects. The principles basic to the co-ordinated classroom were used by the architects in designing this school.

with the specially built furniture. Figures 48 through 53 show before-and-after views of the windows and room interiors, by daylight, of another of the Rosedale rooms fitted with furniture of standard design, but in natural finishes.

No attempt was made at any time, in any of the experimental centers, to study curricular organization, or educational philosophy or methodology. The objectives of all the study efforts were to define the organic needs of children that must be satisfied, and the organic action patterns aroused in them by task situations in an artificial surround that are basic to any learning situation involving close visually-centered activity. While most of the illustrations used in reporting these studies are from formal or semi-formal organizations of school activities (because these are the situations most generally encountered in schools today), no brief is held for any particular type of program organization. The basic principles defined or implied are fundamental and equally applicable to any type of curriculum — formal or informal, narrowly subject-matter centered, or a full-living one.

Since 1946, others have duplicated part or all of the experimental classroom changes in some forty schools extending from Schenectady, N. Y., and Mansfield, Ohio, through Wilmette, Ill., Oshkosh, Wis., and New Orleans, La., on to Ellensburg, Wash., and Monmouth, Ore. Reports of these have appeared in a number of publications from time to time. Figures 54, 55 and 56 show two rooms set up to match part of the Texas experiments in the Mansfield, Ohio, Public Schools. The numbers superimposed on the room in Figure 54 are brightness measurements made of this room, reported in footlamberts, by Prof. R. C. Putnam, of the Case Institute of Technology. Architects, also, have utilized many of the principles developed in the Texas program in designing and erecting

schools, not only in Texas, but in Ontario, Washington, Oregon, Mississippi, Louisiana, and several other states. The exterior of one of these new schools is shown in Figure 57. Other pictures and the specifications of this school appeared in a critique of elementary schools written by the editors and published in a recent architectural publication.¹⁴

The medical and testing program, as was stated earlier, had been so arranged that it would evaluate, periodically, the effect on children of any seating, lighting, and painting or decorating procedures worked out in the centers selected for intensive study. It was recognized that many uncontrollable variables, such as motivation factors, etc., could affect the exactness of any findings in these examinations and tests. A number of steps were taken to minimize the effects of such factors. Among these steps were both parallel experiments carried on in a number of schools, as well as repeated medical and testing rechecks, through months of time, to determine how well any gains in well-being held up after the initial experimental period. In addition, the data secured through these examinations and tests was recognized as indicating major trends only, and was not released to indicate absolute values to be expected from every comparable experiment.

The Becker school, in Austin, Texas, was selected as one of the experimental centers during the fall of 1942. At that time Becker school was a five-grade elementary school with an enrolment of 396 children. The curriculum and home rooms were organized by half-grade levels (i.e., 1 A, 1 B, 2 A, 2 B, etc.) and children were advanced by both June and mid-year promotions. Instruction, after grade 2 B, was through a modified platoon system, with some of the children's work conducted in their own home rooms, and some conducted in either the home rooms of other children or in special rooms.

Twenty-one rooms in the building were assigned as classrooms, and, with the exception of grades 5 A and 5 B with one section each, there were at least two separate sections of each of the other half-grade levels. The children were principally of Anglo-American descent, and they came from homes of average means. The building was modern in construction (with classrooms closely resembling the one in Figures 48 through 50 showing a Rosedale school classroom before changes were made), and it was part of a progressive school system in an urban community. The medical and testing rechecks in the school were set up to continue for two years after completion of the initial six-month intensive experimental period. These rechecks validated the trends found in the six-month data.

The 396 children enrolled in Becker were given thorough pediatrics examinations and nutritional appraisals, and visual, psychological, achievement, and other tests in November, 1942, immediately prior to



Figure 58

Exterior view of the rebuilt portion of Rosedale School, showing light-directional glass block and vision strip hooded against high sky glare and sun.

making any classroom changes. Some of the findings of these initial tests and examinations are shown in the accompanying tables and charts. Among these initial findings were test results showing that 53.3 per cent of the 396 children enrolled in Becker school had functional and organic visual difficulties significantly affecting their work in school. This was the same as the percentage of children who had visual difficulties in all the demonstration schools. There were twice as many children with these visual difficulties in the grades 3 B as there were in the grades 1 A; and the number with visual problems in the grade 5 A were approximately one-sixth greater than those in the grades 3 B. The visual tests were in terms of the difficulties affecting the children's work in school, so they did not necessarily indicate that all the children found with visual difficulties required glasses. The tests did indicate that some factor existed preventing these children from "seeing" in their classroom work like children whose eyes met accepted standards for normal vision.

Medical appraisals and laboratory tests indicated that approximately 70.0 per cent of the children had signs accepted by medical nutritionists as indicative of nutritional difficulties. A published analysis of these nutritional findings, made by the medical examiner in charge in one of the medical journals¹⁵, shows a high correlation existed between these nutritional difficulties and certain classroom factors, and also with the low educational, developmental, and other test scores found in the children.

Two or more ear, nose, or throat signs, with accompanying lymphatic involvement, appearing in a child were used as a crude index of chronic infection. Three-quarters of the children examined showed these signs, pointing to possible chronic infection. Some of the other difficulties found are listed in the November, 1942, column of Figure 59.

Immediately following the examinations and test of these children, the twenty-one classrooms in the building were rearranged and redecorated, according to the methods discussed later, to promote more effective per-

14. "I. Parochial School, Houston, Texas by Coleman and Rolfe, Architects", Pp. 52-56, *Progressive Architecture*, November, 1948.

15. J. M. Coleman, M.D., F.A.A.P. — "Nutritional Deficiencies Among Texas Children, etc.", *Texas State Journal of Medicine*, February, 1945.

Figure 59
COMPARISON OF SOME HEALTH PROBLEMS
FOUND AT BEGINNING AND END OF THE SIX-
MONTH EXPERIMENTAL PERIOD
 November, 1942, and May, 1943.
 Becker School, Austin, Texas

PROBLEM	Per cent of cases found in November 1942	Per cent of cases found in May 1943*	Percentage change during six-month period
Visual Difficulties.....	53.3	18.6	-65.0
Nutrition Problems.....	71.3	37.2	-47.8
Chronic Infection.....	75.2	42.6	-43.3
Posture Problems.....	30.2	22.4	-25.6
Chronic Fatigue.....	20.9	9.3	-55.6

* Children entering school after November, 1942, eliminated from this table.

Figure 60
COMPARISON OF VISUAL DIFFICULTIES
FOUND AT BEGINNING AND END OF THE SIX-
MONTH EXPERIMENTAL PERIOD
 November, 1942, and May, 1943.
 Becker School, Austin, Texas
 Shown Graphically in Figure 62

GRADE LEVEL	Per cent of cases found in November 1942	Per cent of cases found in May 1943*	Percentage change during six-month period
ENTIRE SCHOOL.....	53.3	18.6	-65.0
Grade 1A.....	30.7	7.6	-75.0
Grade 1B.....	35.7	21.4	-40.0
Grade 2A.....	38.4	23.0	-40.0
Grade 2B.....	46.1	23.0	-50.0
Grade 3A.....	58.3	8.3	-85.7
Grade 3B.....	61.5	15.3	-75.0
Grade 4A.....	66.6	20.0	-70.0
Grade 4B.....	72.7	27.2	-62.5
Grade 5A.....	71.4	21.4	-70.0

* Children entering school after November, 1942, eliminated from this table.

Figure 61
COMPARISON OF NUTRITION PROBLEMS
FOUND AT BEGINNING AND END OF THE SIX-
MONTH EXPERIMENTAL PERIOD
 November, 1942, and May, 1943.
 Becker School, Austin, Texas
 Shown Graphically in Figure 63

GRADE LEVEL	Per cent of cases found in November 1942	Per cent of cases found in May 1943*	Percentage change during six-month period
ENTIRE SCHOOL.....	71.3	37.2	-47.8
Grade 1A.....	57.1	57.1	0.0
Grade 1B.....	53.3	13.3	-75.0
Grade 2A.....	80.0	33.3	-58.3
Grade 2B.....	80.0	66.6	-16.6
Grade 3A.....	71.4	28.5	-60.0
Grade 3B.....	85.7	21.4	-75.0
Grade 4A.....	73.3	33.3	-54.5
Grade 4B.....	84.6	30.7	-63.6
Grade 5A.....	57.1	28.5	-50.0

* Children entering school after November, 1942, eliminated from this table.

formance of the children, and to free them as far as possible from adverse stress.

With the exception of the rooms used by grade levels 1 A and 2 B (involving more than one room for each grade level), all the home rooms in the building had individual seats for each child. Grade levels 1 A and 2 B were equipped with tables arranged in units so that eight children sat around a unit with four on each side. These children could not be seated so as to fully eliminate body shadows or protect many of them from all of the sky glare, or to permit full freedom of performance until some of their seating was changed four months after the intensive testing program began.

In May, 1943, six months after the rooms had been redecorated, the daylight controls installed, and the seating rearranged, the children were again given the medical and nutritional examinations and the visual, psychological, and education tests. At this time only 18.6% of those examined in November showed visual difficulties, a reduction of 65.0% in the visual problems found in the tests given to these same children six months previously. In addition, the nutrition problems had dropped 47.8%, and the signs of chronic infection had been reduced 43.3 per cent. The May, 1943, findings, with the amount of reduction from the November, 1942, findings, are shown in the last two columns of Figure 59.

A grade-by-grade examination of the May, 1943, data showed that these reductions in health problems were fairly uniform throughout all the half-grade levels in the Becker school. The only exceptions were limited reductions in nutrition problems in grade levels 1 A and 2 B. However, even these poor results at these grade levels pointed to the apparent place that well-planned seating and working equipment have in promoting well-being. In these rooms, with multi-place flat-top tables instead of individual seats, only the decorations and some incomplete control-methods for daylight could be changed at the beginning of the experimental period. Children seated at these tables were exposed to some sky glare and they were limited in their freedom of performance by the flat tables for most of the experimental period. A comparison of the nutrition improvement in these grade levels, with that in the other grade levels, as seen in Figures 61 and 63, shows the probably adverse effect through excessive energy consumption of the restraint of these tables.

In addition to the apparent improvements in physical well-being resulting from co-ordinated planning of lighting, seating, and decoration, some comparable results were obtained in educational achievement, as well. An objective achievement test, measuring educational growth in terms of months of Educational Age, was given the children in the experimental building at the beginning and end of the six-month period. The same achievement test was given a comparable group of children in a comparable control building, but in which no lighting, seating, or decoration changes were made.

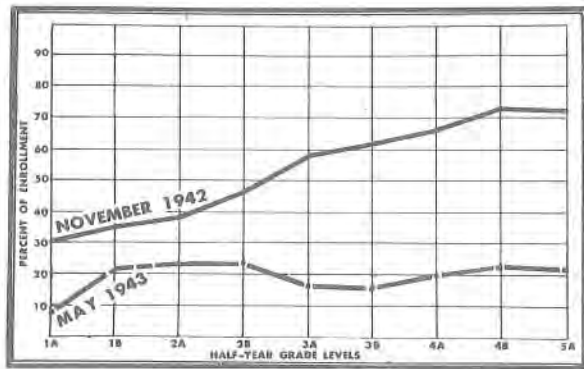

Figure 62

Comparison of visual difficulties found at the beginning and end of six-month experimental period — November, 1942 to May, 1943 — at the Becker School, Austin, Texas.

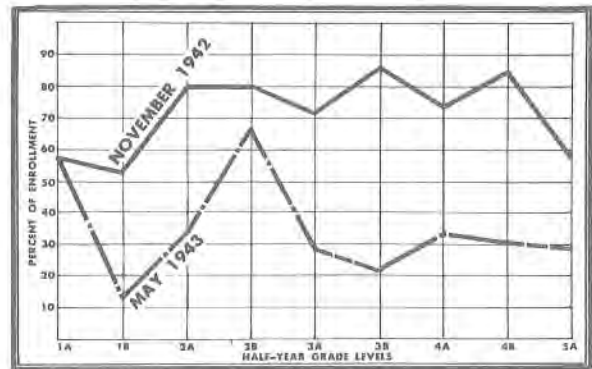

Figure 63

Comparison of nutritional difficulties found at the beginning and end of six-month experiment period — November, 1942 to May, 1943 — at the Becker School, Austin, Texas.

In the six-month period of working in the improved classroom environments, the children in the Becker school grew a mean average of 10.2 months in educational age, with a median growth of 10 months and a modal growth of 10 months. Seventy-six per cent of the children grew educationally over six months of educational age in the six-calendar-month interval. In the control school, the mean educational growth was 6.8 months of educational age, the median six months, and the modal growth was six months. Only 33.4 per

cent of the children in the control school grew educationally over six months of educational age. The educational growth in the control school represents the situation ordinarily expected in the average elementary school. The table at the end of this section, Figure 64, shows the grade-by-grade distribution of educational growth.¹⁶

Since conducting these first tests of the effects on school children of better coordination of the physical factors in their classrooms, comparable experiments have been conducted in a number of other school systems throughout the country with apparently comparable results. The minimum essentials for planning a co-ordinated classroom environment, as determined by these experiments, is discussed in detail in the section which follows.

16. The data and material presented up to this point digests the substance of three of the writer's so-far unpublished papers: "The School Environment as a Factor in Growth Deviation"; read before the Sixteenth Annual Meeting, American Academy of Pediatrics, Dallas, December 10, 1947; "The Classroom as a Factor in Growth Deviation", presented to the Ninety-Seventh Annual Session, Scientific Assembly, American Medical Association, Chicago, June 24, 1948; and, "Light on Growing Children", read before the Mid-West Area Meeting, American Academy of Pediatrics, Milwaukee, June 29, 1948, and the Western Area Meeting, American Academy of Pediatrics, Seattle, September 14, 1948.

Figure 64
ACHIEVEMENT GROWTH BY MONTHS OF EDUCATIONAL AGE DURING
THE SIX-MONTH EXPERIMENTAL PERIOD
 November, 1942 to May, 1943.
 Becker School, Austin, Texas

	Range of growth	Mean change	Median change	Modal change	Per cent changing 6 mo. or less	Per cent changing less than 6 mo.	Per cent changing 6 mo. only	Per cent changing over 6 mo.
	Months	Months	Months	Months				
Experimental School.....	0-32	10.2	10.0	10.0	24.0	16.6	7.4	76.0
Grade 1A.....	0-18	9.8	9.0	9.0	25.0	18.7	6.3	75.0
Grade 1B.....	0-21	10.8	11.5	10.5	14.2	14.2	0.0	85.8
Grade 2A.....	4-19	10.9	9.0	8.3	9.0	6.0	3.0	91.0
Grade 2B.....	4-17	9.4	9.0	9.0	26.6	20.0	6.6	73.4
Grade 3A.....	6-24	11.7	11.0	10.9	10.5	0.0	10.5	89.5
Grade 3B.....	2-32	13.5	14.5	14.5	16.6	11.1	5.5	83.4
Grade 4A.....	5-25	10.9	10.0	10.0	15.3	7.6	7.7	84.7
Grade 4B.....	4-27	11.8	12.0	11.0	26.3	21.0	5.3	73.7
Grade 5A.....	3-15	8.9	10.0	11.0	24.1	20.6	3.5	75.9
Control School.....	-8 to +18	6.8	6.0	6.0	66.6	44.4	22.2	33.4



Above: Figure 65. Below: Figure 66.

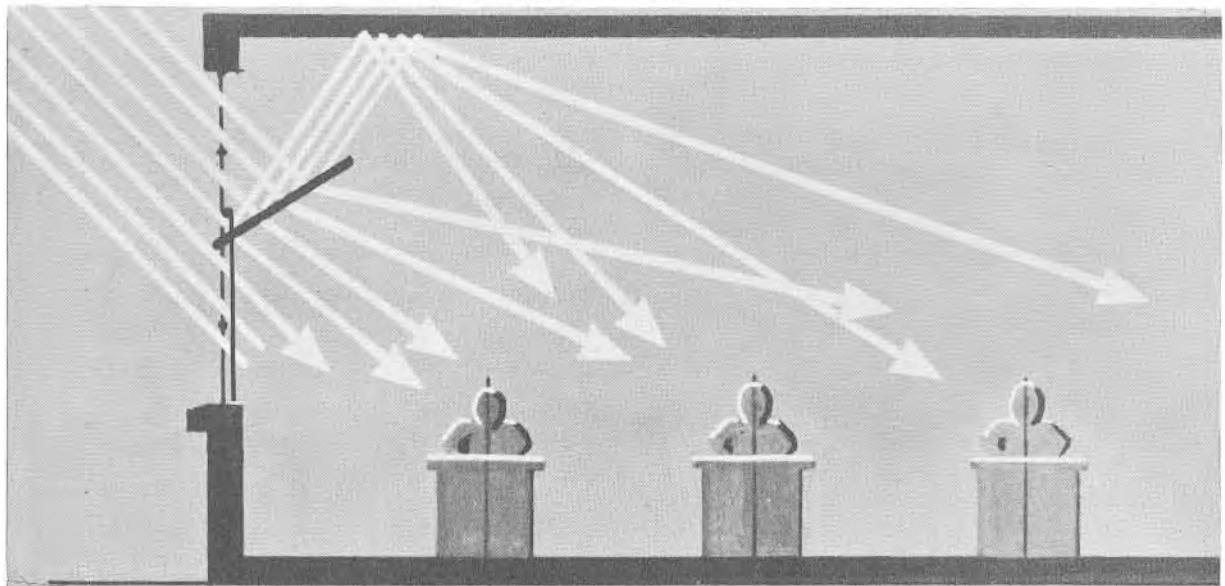

Figures 65 through 68. Figure 65 shows a redecorated room with an installation of single-width diffusers. This is the same room as shown in Figure 67. Both pictures were taken at the same time of day, one week apart; and the outdoor lighting is identical. Figure 68 shows an installation of double-width diffusers in an adjacent redecorated room. This room, before change, was like that in Figure 67; and it was photographed at the same time as Figure 65. Figure 66 is a schematic diagram of the manner in which diffusers function, as described in the text.



Figure 67

For growth—for support against gravity—for balance with the dynamic forces of the environment—for the performance of tasks—the human body strives to organize each pattern of processes, equilibria, and actions required so as to fit some determinable and predicable function on systems of three-dimensional co-ordinates.

Inherent growth processes and body-balancing reflex mechanisms work to attain each of these organizations around those axes of the different systems of co-ordinates which determine the most efficient, most economic, and most satisfying way of meeting the organism's respective needs. Within certain limits of physiological tolerance, these various axes of performance tend to coincide or to complement each other when the organism is fully free to both seek its own surround and to perform. Failures in establishing these relationships lead to disturbances of organic functioning and well-being, alterations or breakdown of structures, and marked limitations or deviations in required performance.

In turn, each of the energies of stimulation and the restraints on performance existing in an environment also distribute as a function on its own system of three-dimensional co-ordinates. The human organism, in its basic actions, attempts to find a balance with the distributions, axes, or resultants of each of these forces.

In a social or artificial environment, cultural demands decisively restrict the human organism in seeking its own surround and defining its own tasks. Consequently, to promote optimum growth, development, and functioning in children, the working environment in which they are required to perform close, sustained, visually-centered tasks, must be so planned and organized that the frames of reference of the forces in the physical surround are in appropriate relationship with each other, and with all the various frames of reference inherent in the action-patterns of the organic child.

This relationship must be such that the environmental vectors setting the child into action, and the organic vectors they arouse, provide appropriate axes of function for both optimum performance of the task and optimum satisfaction of the child's concomitant or associated organic and psychological needs. Gradients of growth, gradients of activity induced by the various controllable and uncontrollable forces in the energy surround (such as gravity, light, sound, and temperature), gradients of adjustment to the working equipment, and, gradients of action required by the task, must so distribute together as to promote the integrity of the total organism, orient the child into the culture of which he is a part, and, fit him for all the environments in which he will subsequently find himself.



Figure 68

Part Three NOTES ON PLANNING A CO-ORDINATED CLASSROOM

This section makes no pretense of furnishing a set of specifications for co-ordinated classrooms. That is the job of the architect. However, function must be defined before structure can be planned, or specifications written. The purpose of this section is to direct attention of school planners to some major factors of classroom function ordinarily neglected or ignored. The obvious, as well as the commonly recognized factors, have been omitted, as have matters of secondary consideration, in order to lay stress on some principles of classroom design of vital importance, if we would provide for optimum development of school children.

The Problem. The preliminary and the intensive studies, previously described, showed that a significant part of the problems of well-being and achievement in school children were related to seating, lighting, and other physical aspects of the classroom surround. When these physical aspects of the classroom were adjusted in certain ways, problems of well-being and of achievement were drastically reduced both in incidence and in severity. The methods and manner of adjusting these physical factors were based on studies of (1) physical growth patterns in children; (2) normal body mechanics; (3) organic adaptive processes; (4) physiological mechanisms for detecting and responding to the energies and physical restraints of the classroom environment; and (5) certain psychophysical functions related to all those above. The studies indicated that these organic and psychophysical factors were neglected in school planning because classroom function had been largely defined in terms of direct psychological and social outcomes of learning, or in terms of social convenience.

Fundamental to psychological and social growth is physiological function. The child learns through activity. Meaning and psychological redirection of generalized behaviors are acquired through directing

THE PROBLEM...



Figure 69

Poorly distributed light, high contrasts, and glare do not permit adequate adaptation of the eyes for full and free performance of the child's visually-centered tasks. This makes for inadequate recognition, visual distress, and improper or damaging body mechanics.



Figure 70

Adequate adaptation is possible only when the light is so distributed over the three dimensions of the room that glare is absent or minimized, and contrasts in the binocular visual field and in the task background (in any working orientation) are kept within the maximum brightness ratio of 3:1.



Figure 71

Highly directional task lighting, and specular (mirror-like) reflections from tasks and working surfaces, make for unresolvable contrasts, "wash out" the retinal pattern of the task stimulus, reduce achievement, disturb needed body balances for efficient performance, and build up physical stress and strain.

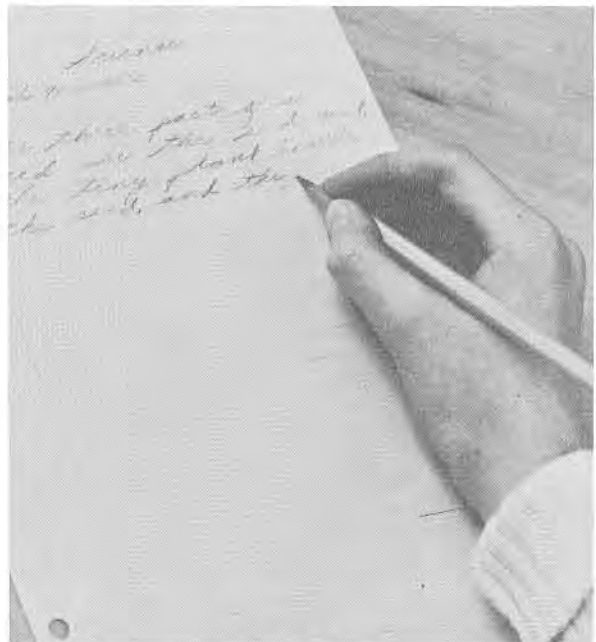

Figure 72

Task lighting on a plane surface should distribute so as to be apparently shadow-free; specularly of visible surfaces should be reduced so that they seem matte within the working visual field; and, bright light sources should be so located or shielded that their reflected brightness in vision areas is less than the brightness of the task.

THE PROBLEM...

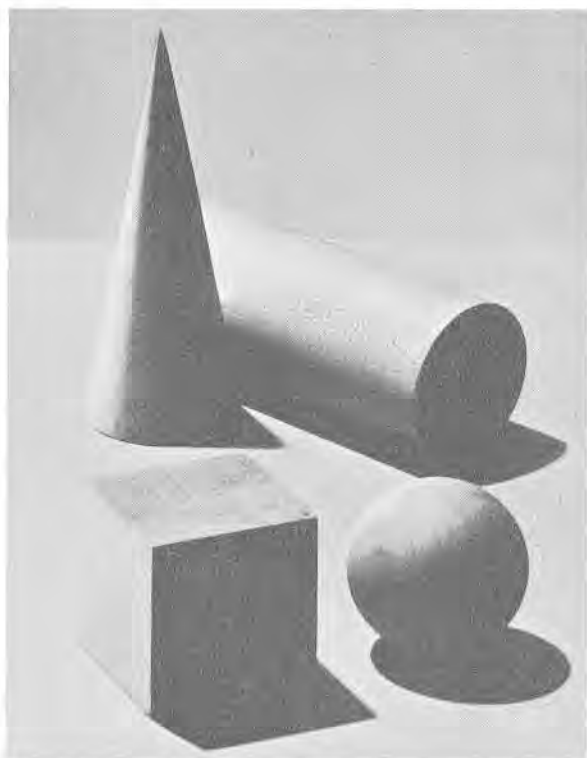

Figure 73

Harsh modelling shadows seriously interfere with needed three-dimensional seeing experience. High modelling contrasts alter adversely the child's interpretation of the depth, form, size, and location in space of three-dimensional objects and tasks, and of the limits and nature of the artificial surround.

the organic child into performances, implicit and overt, which satisfy basic biological and psycho-physical needs aroused by the specific surround, yet which simultaneously through association, synthesis, abstraction, and unification of all factors in past and present experience, lead him to acquire adequate concepts and symbols for understanding himself, and his natural and social worlds. The foundations for acculturation come through organic reactions to physical things—whether they are light in general or the light from a printed page, sound per se or the sound of spoken words, the restraints of artifacts such as furniture or buildings, or the physical restraints of natural structures or forces.

The organism as such, fits itself, through adaptation, to the specific patterns of physical energies and restraints in its environments, by shifting growth and altering structure and function to meet immediate need for static and dynamic balances with these energies and restraints. How advantageous or handicapping these changes of structure and function are in subsequent situations and environments depends upon how well the energies and restraints producing them have been within the tolerances of the organism; have permitted achievement of needed balances; and, have not

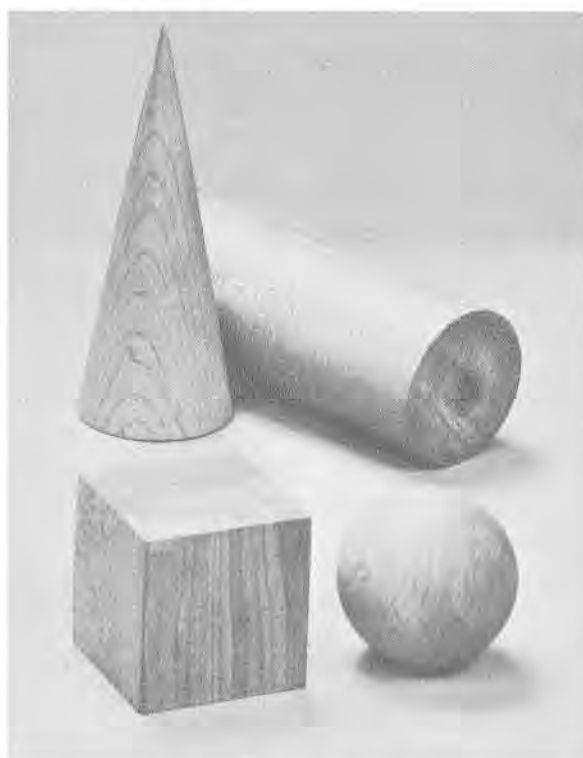

Figure 74

Modelling shadows are necessary for three-dimensional seeing. They should be soft, graded, and "transparent" (well within the adaptation limits of the eyes for the surround) so as to define clearly contour, location, relationship, and size. Limits of their brightness ratios should be not less than 3:1 or over 7:1.

interfered with optimum total functioning of the whole organism.

The psycho-physical basis for learning is the direction of movement—free unrestrained direction of movement in relation to: the axes of the body; the co-ordinates of certain optimum reflex patterns for physiologic balance; the co-ordinates of the organism's orientation to itself in its experientially defined space world; the co-ordinates of the stimulating energies of the surround; the co-ordinates of the physical limits of the surround; and, the co-ordinates of the required tasks and their supporting structures. For optimum development, all these co-ordinates must be so planned that they in coincidence for some related functions, or provide physiologically appropriate definition for transformations and transformation groups integrating all of the child's organic behaviors.

Consideration of all this is a large order in defining classroom function and planning classroom structure, but the vectors of environmental stimulation must be so controlled and related, that, with the organic vectors they arouse, they provide appropriate axes of total function for the organism in the direction of movement, if the physiological, psychological, and social functions of the classroom are to be met.

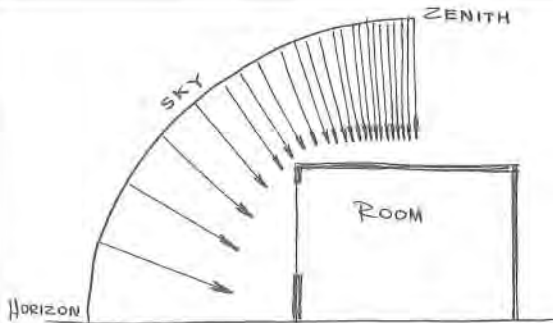

In effect, daylight comes from a diffuse, hemispherical radiator, the sky, with the principal direction of the path of light, originating in any area, going towards the center of the earth. During the working day, both the quality and the quantity of light tends to improve towards the zenith.

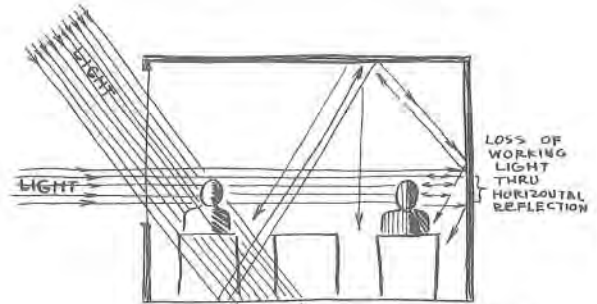

LIGHT LOSS THRU ABSORPTION BY FLOOR, ETC.

Unbalanced distribution of uncontrolled daylight (through clear-glass windows only) makes for glare, high contrasts, and high diversities on working surfaces.

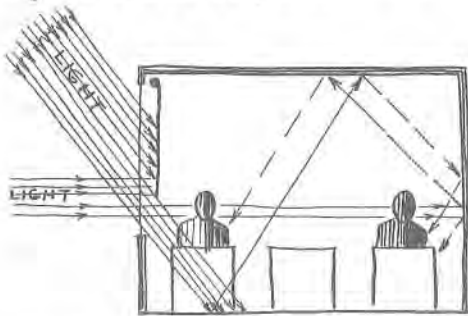

Window shades, alone, reduce glare; but they also reduce the quantity of working light, and their use does not improve either contrast or diversity.

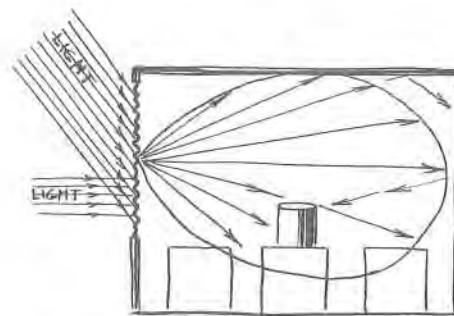

Diffusion windows partially control glare and contrast; but they do not provide adequate distribution of light for proper modelling shadows in three-dimensional seeing.

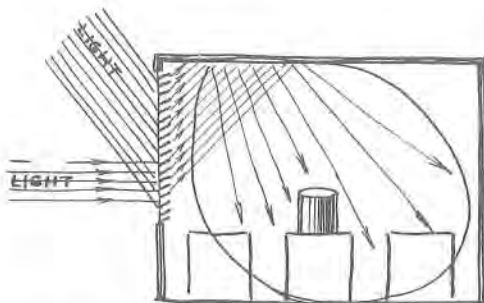

Opaque-louver systems control glare, and smooth out some of the diversity on horizontal working surfaces; but they do not provide adequate light for vertical planes, and they make for inadequate modelling contrasts in three-dimensional seeing.

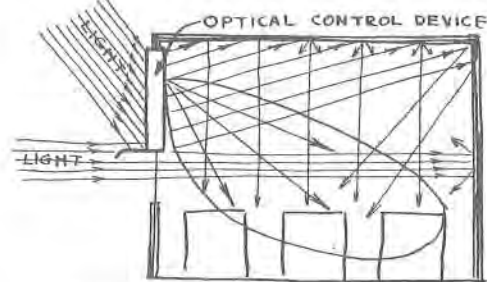

Only an optically designed daylight-control device at the window, which re-directs the largest part of the light upward and into the room, yet provides for both some horizontal direct, and some oblique downward diffuse light, will adequately solve daylight problems of glare, high contrasts, excessive diversity, and improper three-dimensional modelling shadows.

FIGURE 75
SIMPLIFIED SCHEMATIC DIAGRAMS
OF DAYLIGHT-CONTROL PROBLEMS

LIGHT CONTROL

Research in vision in recent years has been demonstrating that seeing is much more than the recognition of details in something illuminated. Vision is proving to be the dominant function in all man's actions and relations with his space world. Visual processes enter into localizing him in space; adjusting his balance and posture in efficient relationship with that which he wants or needs to manipulate; holding his body in support; identifying the significant factors or symbols in the surround; synthesizing and unifying other sensations and experiences with the immediately visual ones to derive meaning; determining direction of manipulatory movement; and, establishing needed biological and psychological equilibria. From organic survival to social demand, no one of these visually-related processes can receive emphasis to the exclusion of others if organic and psychological man is to function efficiently.

With this importance of vision, its correlate — light — then is the dominant energy in man's surround. Light's characteristics of quantity and quality in any environment are among the major determinants of the efficiency of all the visual processes in that environment. The control of light, therefore, becomes one of the principal functions of those planning man's artificial working environments — especially the classrooms of children in which they should adapt and develop all their innate resources in an optimum manner for their own and society's good.

The last few years have seen some tremendous forward steps taken in determining and codifying the principles and practices of classroom lighting. Special mention should be made of the underlying researches and of the work which resulted in the 1948 American Standard Practices for School Lighting.

There are, however, certain essential shortcomings implicit in these researches and recommended practices due to the emphasis placed on only one of the visual processes — central retinal function in the identification of detail in a task¹⁷. First among these shortcomings, as applied to school lighting, is the implied assumption that all of the child's tasks in school are limited to reading or some other similar aspects of the three R's, with the visual task confined to recognition of symbols presented on a plane. Associated with this is the assumption that each child's working position is a fixed one, limited to one or not over two orientations — the desk surface and the chalkboard. Modern curricular development in even formally conducted schools is demonstrating the fallacy of these assumptions. The child in school learns not only through symbolic experiences contained in printed and written words, but also, and equally as much, through the primary experiences of construction, manipulation,

17. The "light sense" is concerned with more than the resolution of task detail, which is the "statics" of visual centered performance. It is also related to the "dynamics" of that performance in that it is concerned with the appropriate resolution of all contrasts in the visual field; the psycho-physical organization of these contrast patterns so as to define space and location and the child's orientation in that space; the direction of the child's purposeful movements in relation to his task and space; and, the establishment of physiological balances with the quantities of energy represented by those contrasts.

FIGURE 76

For Optimum Lighting, providing a "smooth" distribution of light on horizontal, vertical, and other plane working surfaces — well inside contrast and other tolerance of the eye —

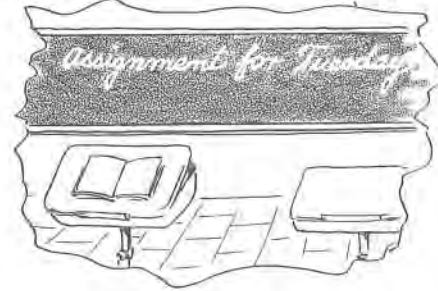

...but also providing adequate modelling shadows for three-dimensional seeing

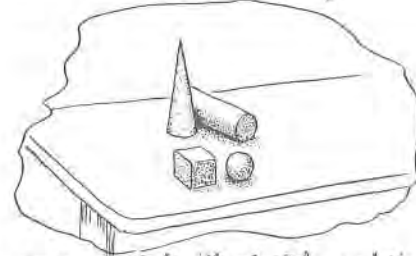

...the room must be illuminated as a "light solid" with the light apparently coming, by diffuse transmission or reflection, from above working eye level. The ceiling should seem to be the primary source, with the upper portion of walls or windows making the apparent secondary source, increasing in brightness in an upward direction to blend with ceiling brightness.

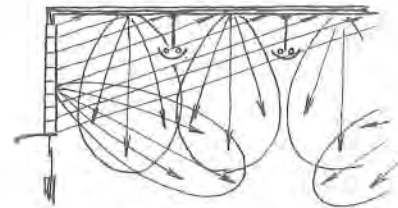

The light should distribute in such a manner that the "light solid" is somewhat "tilted", so that the resultant of the light energy is at an angle to the vertical center line of the room (preferably to the left), but creating not over a 2.5:1 diversity on the horizontal.

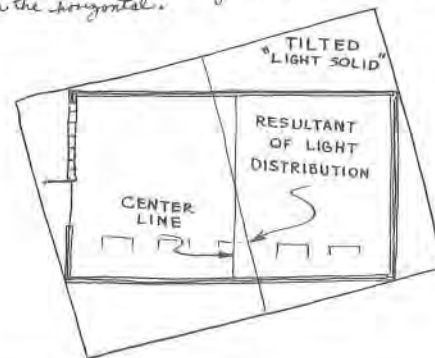



Figure 77

A poorly planned and lighted south classroom, showing high contrasts, glare, and improper distribution of light for adequate adaptation of eyes for all seeing tasks within the room. (Adaptation can be evaluated by noting the light contrast between the two sides of the children's faces. This should be low.)



Figure 78

The same classroom as in Figure 77, photographed immediately afterward but with the upper shades pulled. Notice that, while some veiling glare is removed, the working level of light is drastically reduced, and high contrasts and the faulty distribution interfering with eye adaptation still exist.

and demonstration of many of the objects and processes for which those written words stand. The child learns through activity—all-over activity—and, of necessity, his orientations change because of this activity. His orientation in the classroom changes constantly throughout the day. His visually-centered tasks range through horizontally, vertically, and angularly placed "plane" tasks; through reading, writing, drawing, teacher-centered demonstrations both in plane and solid, and through individual and group three-dimensional construction activities; through the practice of various individual skills in all these, and through participation in social activities.

Even the child's location in the room changes throughout the day as new centers of activity are organized to provide all his needed educational experiences. No longer is it possible to plan lighting only in terms of adequately illuminating the central field of vision at a fixed-task focal point, such as emphasizing the horizontal distribution of light on desks, or the vertical lighting on chalkboards.

Classroom lighting plans must provide for a light distribution pattern permitting the child to orient at almost any position in the room consistent with good body balance for performing a visually-centered task, and to find the quantity and quality of light appropriate for both the critical recognition of detail and for the full and free performance of the required task. Such a distribution pattern must recognize that the tasks at any position can be either on a plane, requiring certain limitations of contrast between task and background, or in three dimensions requiring not only those same limitations of contrast but also necessitating modelling shadows adequate to define the contours of the task without obscuring its details.

Current recommended practices tell us that the contrast between a seeing task and the immediately surrounding surfaces would be ideal at unity but

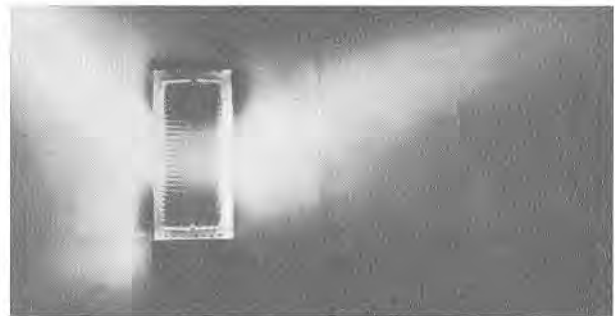

Figure 79

Photographic demonstration of the light-controlling properties of an effectively designed light-directional glass block. The incident light is to the left of the block cross-section, and the block-controlled light is to the right. Note that most of the light is being directed upward and inward at a relatively constant angle, as it should be, but there is also some downward and inward diffusely transmitted light vitally necessary for proper three-dimensional distribution.

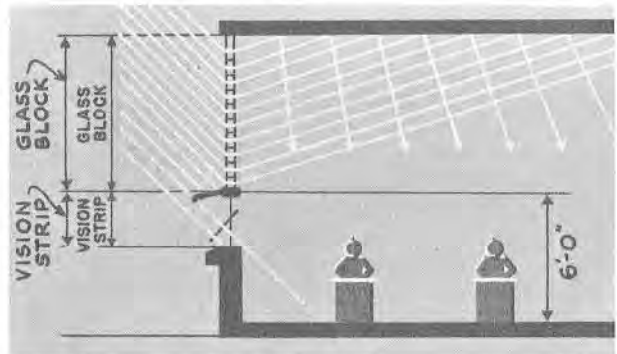

Figure 80

Schematic cross-section of functional installation of light-directional glass block in a classroom. Note height of first course of block from the floor, provision of a vision strip with an opaque outside hood cutting off high brightness of upper sky at 45° from sill, and, the relative sill height to seated eye-height.

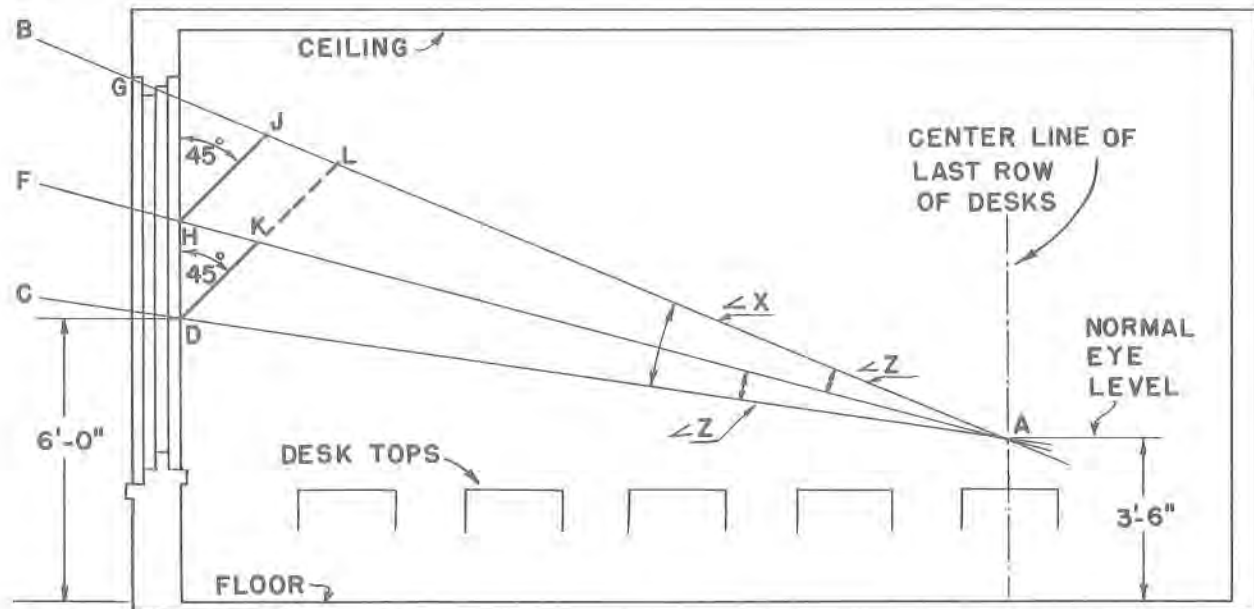

Figure 81 (above)

Diagrammatic method of calculating mounting dimensions for light diffusers. This should be done on scale cross-section drawing of room. First locate point "A" 3'6" above floor level at center of working surface nearest corridor wall. Then locate point "D" on inside window wall. Point "G" is outside edge of lintel. Draw line "AC" through point "D", and line "AB" through point "G." This forms angle "X." Bisect angle "X," giving angle "Z." Draw 45° lines "DK" and "HJ." Measure to scale "DK" and "HJ"; these represent widths of diffusers for double-row installation. Points "D" and "H" represent mounting heights for these diffusers. "DL" represents width, and "D" mounting height, if only a single row of diffusers is used. Rows should run continuous for length of fenestration, with overlap of walls at ends to eliminate light streaks. Some type of shade should be provided to cover vision strip from "D" to sill.

should not exceed 1 to 1/3, and between the task and the more remote surfaces should not be less than 1 to 1/10 or over 1 to 10. While these standards might be applicable to fixed position working surfaces, with the changes in orientation the child makes in a modern classroom there can be no fixed periphery. Any area can and does become central. Because of this, in any possible binocular field of a child (approximately 50° in any direction from his line of sight) background brightnesses should never exceed task brightness or be less than the recommended 1-to-1/3 ratio. While no recommended practices exist for modelling shadow contrasts, tests made by the writer indicate that the probable optimum range is from not less than 3 to 1 to not over 7 to 1.

A dominantly directional light-distribution pattern would not allow all the orientations and tasks necessary in a modern classroom. The only distribution pattern that will satisfy all the child's needs, would be one that would provide a comparatively even distribution of light in all dimensions of the visually purposeful areas of the classroom — a "light solid," in other words. This concept is diagrammed in Figure 76.

The primary light source in the public-school classroom is daylight. This is especially true in those classrooms of the elementary school where it is found necessary for psychological reasons, to integrate the more familiar surroundings of the child — the outdoors — with his environment away from home, the classroom — by providing a vision strip. Daylight is of such a nature, however, that it must be controlled if it is to be made useful within the limits of critical seeing imposed by the various classroom tasks. The essential problems of this control are presented in Figure 75. As can be seen from this figure, optically designed controls are necessary for the results required. Two methods for this optical control of daylight were used in the studies reported earlier: light-directional glass block, of the type and in the manner

illustrated in Figures 79 and 80; and, an auxiliary diffuser system illustrated in Figures 65, 66, 67, 68, and 81. Economics is the deciding factor in choosing between these two methods. The light-directional glass block is more desirable for new construction, and the light diffusers can be used in buildings being renovated, where costs of wall changes are not justified. The vision strips below either of these daylight-control devices should be equipped with shades for controlling adverse horizontal brightness when necessary.

Artificial lighting must be provided in all classrooms — even those used in the daytime only — to supplement the daylight on those occasions when adverse weather reduces the light level below that needed for optimum visual performance. The subject of artificial lighting has been well covered in the American Standard Practice for School Lighting, so there is no need for more than the addition of a few points here. The quantity of artificial lighting provided to supplement daylight should be sufficient to

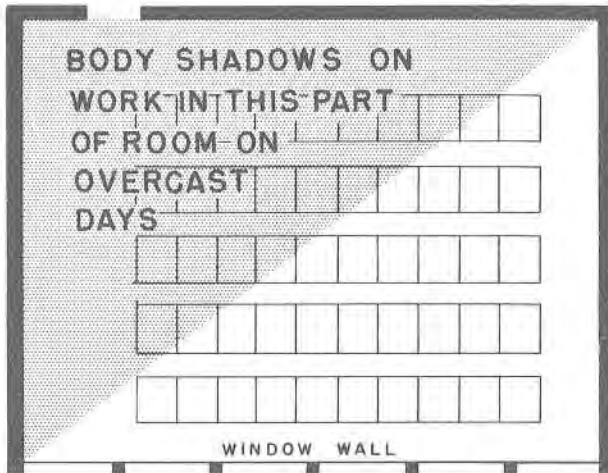

Figure 82

Schematic floor plan of room, showing area of room in which body-shadows are cast on work, on an overcast day, even in rooms with optical control of daylight. This is due to the amount of horizontally transmitted light through the vision strip being relatively higher than the light coming from the upper sky through the optical control devices.

keep the light level throughout the room — from combined sources — up to the minimum recommended in those standards, but never below that falling on desk surfaces near the windows. The latter value is necessary if the children are to have freedom of orientation and performance while the artificial lighting is in use. In most rooms it will be found that this required minimum light level from combined sources is above that recommended as minimum levels in the American Standard Practices.

Artificial lighting used to supplement daylight in



Figure 84

Night view of properly decorated and equipped formal classroom, lighted with three continuous rows of louvred-direct lighting (3 rows, 7 each 2-40 watt luminaires). Note predominant vertically-downward direction of light, giving good distribution of light on horizontal working surfaces. There is some adverse reflection of the high brightness of the bare lamps on working surfaces where they are mounted over desks, even though the eyes are shielded from lamps by louvers.

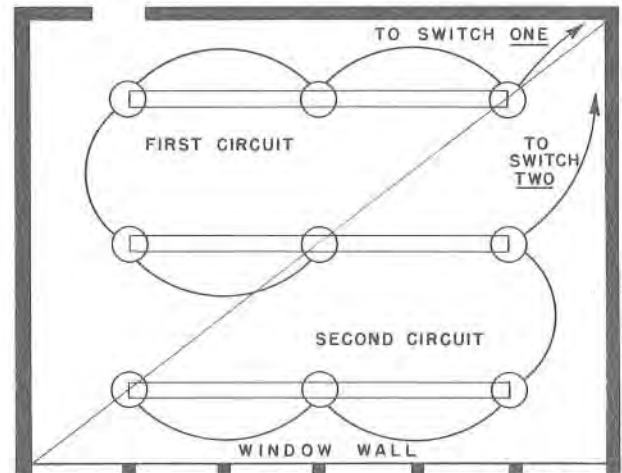

Figure 83

Schematic wiring diagram for supplementary artificial lighting for dark, overcast days, laid out to eliminate shadows in Figure 82, and to maintain proper light-distribution pattern. Circles indicate minimum plan for incandescent lighting; parallel lines indicate minimum plan for fluorescent lighting. Circuit ONE is used on dark days, circuits ONE and TWO at night.

classrooms should be distributed in the room according to the same pattern the daylight distributes; otherwise, it will not supplement but will conflict. Figures 82, 83, 84, 85, and 86 illustrate some of the problems of artificial light distribution. There is the same need for maintaining the "light solid" with artificial lighting as there is with daylighting, so lighting equipment should be carefully chosen and installed, not for price, but for performance and the economics inherent in adequate seeing and the resulting optimum development of school children.



Figure 85

Night view of properly decorated and equipped formal classroom, lighted with four continuous rows of luminous-indirect fluorescent lighting (4 rows, 6 each 2-40 watt luminaires). Note excellent three-dimensional distribution of light, giving adequate spatial definition with sufficient task lighting. Depending upon distribution through reflected light, there is some light loss on working surfaces next to corridor wall chalkboards, due to light absorption by chalkboards darker than walls.

DECORATION

Equally important with adequate optically-designed fenestration and artificial lighting in a co-ordinated classroom is properly planned decoration. Decoration in a working environment — especially that of the child in school — serves a number of major functions in addition to the purely "esthetic." The final refinement of the balances of light distribution and of brightnesses so that task recognition and visual field tolerances are met, depends upon the room decoration. Decoration patterns in most classrooms also must be relied upon to provide, through reflection and inter-reflection, the secondary light sources necessary to create the "light solid" indicated in Figure 76 as being needed for optimum three-dimensional seeing. In addition to these two physical functions in relation to light distribution, the decoration pattern must combine with structural factors of the room to satisfy certain major psycho-physical functions, as well.

Together with the structural lines of the room, the decoration pattern must satisfactorily define for the child the spatial co-ordinates towards and within which he performs. Combined with structural lines, room decoration must provide a background for the child's tasks which clearly define those tasks and accurately localize them in the child's three-dimensional space world¹⁸; it must, as accurately, define the limits of the child's functional space; and, it must integrate the structural limits of the room into a three-dimensional "whole" in such a manner that there will be a perceptual "match" of those limits, and the factors making them, in all the child's modalities. Finally, decoration must accomplish all these without restraining or maldirecting the free, adaptive performances of the child.

To meet both its physical and its psycho-physical purposes, classroom decoration must be planned in

18. The major importance of this "space-world" concept will be seen on publication of the work done in studying the development of vision in children at the Yale University Clinic on Child Development, under the direction of Dr. Arnold Gesell.

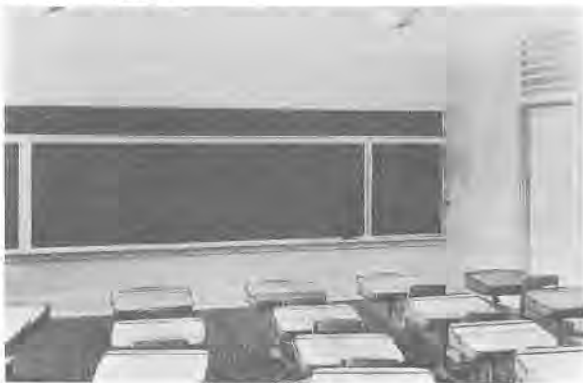

Figure 86

Night view of properly decorated and equipped formal classroom lighted with six equally-spaced 500-watt luminous-indirect incandescent luminaires. Note that light tends to distribute in three dimensions like that in Figure 85, with good spatial definition and task lighting. Due to wide spacing between luminaires, however (because not enough of them were installed to provide an even light distribution pattern), there is a dropping off of light in areas between luminaires.

keeping with the functional and operational limits of two of the visual senses: the light sense, and the color sense. Three of these related to the light sense are of particular interest to us here: (1) the child tends, reflexly, to center his body on the brightest area in his surround; (2) he reflexly adjusts his posture to distribute the remaining contrasts in his visual field equally over the retina so that these contrasts will have their gradients centering on lines representing what should be the frame of reference or co-ordinates of his body; and, (3) he comes to balance in a manner adequate to support the mechanisms (visual and motor) entering into performing his tasks, and still has freedom to perform them, only when the actual physical limits of his surround are properly defined for him.

From the viewpoint of decoration, these limits mean that if the child is to be free to perform his visually-centered tasks in all the various orientations modern curricular development is indicating (with his central field contrast tolerances limited to a ratio of 1 to 3), the decoration must be so planned that various background brightnesses in any dimension of the visual field approach unity. There must be no more contrast than is necessary to define spatial relationships and function without interfering with the central tasks. This situation requires a high-reflectance, low-contrast decoration plan. Second, because the background must accurately describe task location and the limits of function in order to define reference positions for support and direction if organic functioning, and a "light plane" alone is not sufficiently definitive for these descriptions, the decoration plan must be one that will give texture and substance to the limits of the room and to the placement and form of objects within the room.

These two factors provide limits for defining the function of materials used for finishes in the decoration plan. The finishes must be of high reflectance, apparently non-specular (unless specularity in some areas has a purpose in determining the performance of the child), and they must be of such quality that they will maintain these characteristics throughout their planned life.

Reflectances. Starting with the reflectances of the most typical school tasks, (the close "two-dimensional" tasks such as reading and writing which have a reflectances range from 55% to 70%¹⁹), because those reflectances are comparatively fixed under present ranges of recommended light quantities as a result of the nature of the task details which must be resolved, a scale of reflectance ranges can be constructed for the surround of uniformly illuminated surfaces. These ideal reflectances can then be corrected in specific environments to allow for, or to correct, any lack of uniformity in the distribution of incident light.

Some basic principles can be derived from the psycho-physical functions of vision, for constructing these reflectance ranges. Among these are: (1) every brightness area of major size within the field of vision

19. Based on measurements made in the Texas Studios.

should function to maintain the adaptation level of the eyes set by the critical seeing task; (2) brightness areas angularly placed to the line of sight have an effect on vision less than that of the same brightnesses placed normal to the sight line; and, (3) the brightnesses throughout any binocular field, set up by curricularly required changes in task orientation, must distribute in a manner so that their resultants or their vectors of stimulation will center on the natural, balanced line of sight for any task.

Wall Reflectances. Acting as distributors of light, walls should have the highest possible reflectance. However, this is not the only factor that must be considered in defining wall reflectances. The portions of the walls that could be in a plane parallel with the plane of any task cannot be significantly brighter than the task itself without interfering with performance levels, even if they do not interfere with recognition of details of the task. Walls, also, must define clearly both the limits of space and, by means of contrast, the localization and nature of objects and the supporting surfaces for tasks that lie between the walls and the child. Because most objects and working surfaces cannot be constructed of materials having a brightness as high as critical task brightness, without interfering with task performance, wall brightnesses must be higher than object or working surface brightness. A third consideration also helps in defining wall brightness. Walls are on the line of sight when the child is gazing horizontally or fixating on a wall-centered task, but they are angular to his line of sight when the child is centering on a desk or table task. Hence, their effective brightness changes as the child shifts from a vertical centering to an angular or horizontal one. As the largest areas in the visual field, however, the principal wall surfaces must function to maintain visual adaptation for the critical tasks, which means they must approach task brightness.

With all this in mind in planning wall decoration, it becomes obvious that the most effective reflectance range for the principal wall areas within required visual fields should be the same as the reflectance

range for critical tasks, i.e., 55% to 70%. Surfaces outside these visual fields, such as ceilings and, in most classrooms, the walls from approximately nine and a half feet from the floor to the ceiling, function almost solely as distributors of light. These, then, should be of the highest possible reflectance consistent with maintainable finish materials, which is 85% or slightly higher.

As will be noted later, the lowest possible reflectance for working surfaces is 35%, which in turn sets the upper limit for floor reflectances at slightly less than this, or about 30%. The lower limit of floor reflectances is set by the need to keep floors near or within contrast tolerance with the lower limit of critical task reflectances, which in no case would permit the lower reflectance limit of the floors to go below 15%. This, in turn, helps define the reflectance range needed on some of the lower wall areas. In most classrooms, certain portions of the lower walls (in formal rooms this would be the area from chalk rail or bottom of tackboards to the floor on front and corridor walls), together with the floors, come into a more nearly normal position with the line of sight as the child centers on desk tasks. These lower walls, then, should have a reflectance range from an amount not much over three times greater than the lowest limit permissible for floors, up to a reflectance not over the lowest for the task. This would provide a range of from 45% or 50%, to not over 55%. Window-wall areas under the sill, however, should have at least the highest permissible wall reflectance, 70%, in order to reduce the contrast between these surfaces and the vision strip.

A pattern for these various reflectances, needed for both light control and for physiological function, is shown in the diagram, Figure 89. The reflectances shown in this diagram should be applied as indicated in the caption. Those surfaces critical to light distribution, especially ceilings and upper walls above chalk-rail level, must be matte in finish in order to provide the diffuse reflection necessary to build the "light solid" mentioned earlier. All other surfaces



Figure 87

Close visually-centered task placed on a "school-brown" desk top to show adverse effect of high contrast between task and desk top. (Task reflectance, 70%, desk-top reflectance, 13%.) The eyes tend to center on grossest contrast — note conflict in fixation aroused between edge of task and details of task.



Figure 88

The same visually-centered task as in Figure 87 placed on a desk top in natural-wood finish, under the same lighting conditions. (Task reflectance, 70%, desk-top reflectance, 45%.) Note ease of fixating at any point, due to the absence of conflict in centering between task and desk top.

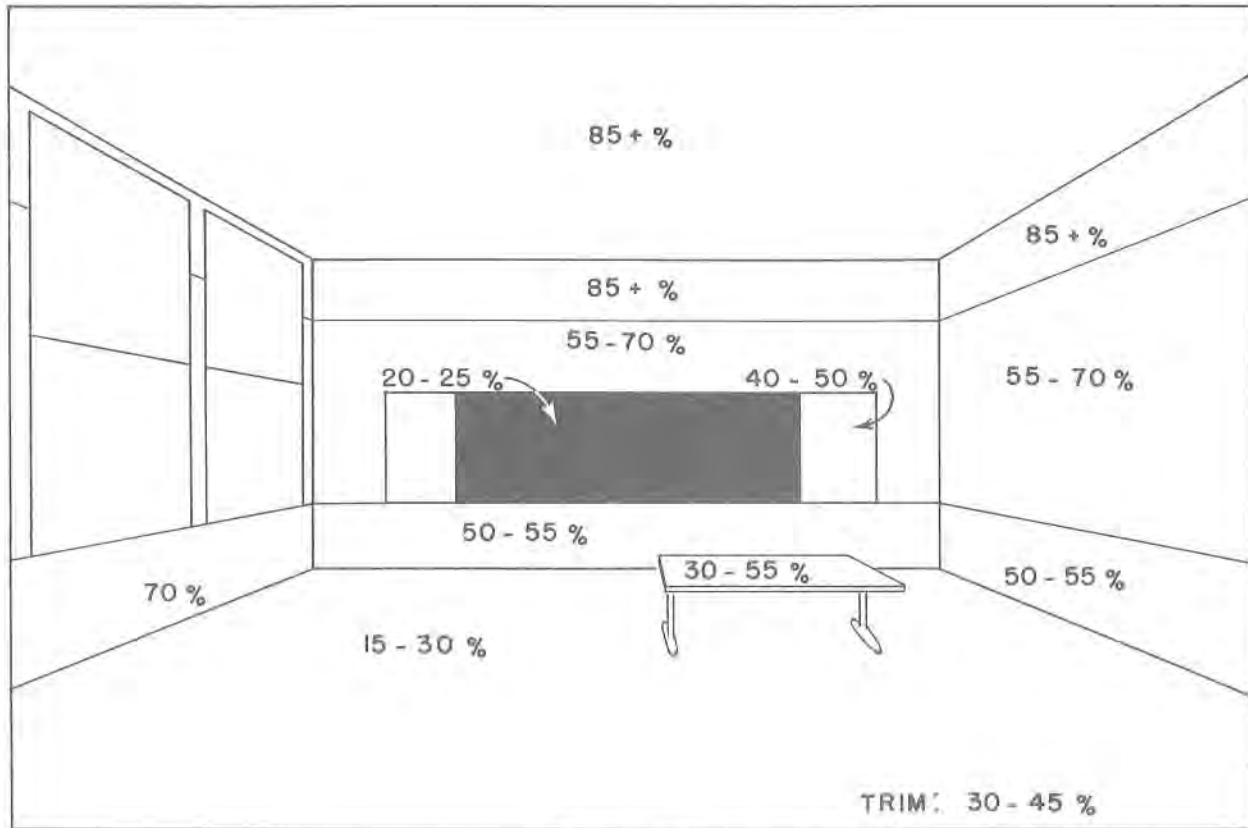

Figure 89

Reflectances for optimum decoration pattern for classroom. With the exception of reflectances shown for furniture, floors, chalkboards, and tackboards, when two reflectance values are shown above for wall finishes, the higher one is indicated for use when optical control devices are used at the window, and the lower values indicate wall reflectances for use with clear-glass fenestration. The two values shown for floors, furniture, chalkboards, and tackboards, indicate reflectance range limits.

within working visual fields should be apparently non-specular also, but when these surfaces are in areas presenting heavy maintenance problems, they may be finished in low or semi-gloss, provided they are rubbed down after the finish application, to direct the angle of specular reflection away from the line of sight of any child in the room.

Working-Surface Reflectances. In a near task, the child tends to reflexly center on any possible gross contrasts in his central field, to the detriment of his performance in relation to the finer contrasts, or details, of his task. With dark-finished working surfaces (such as "school brown," with a typical reflectance of 13%) the grossest contrast would be the book or paper to the desk, and not the type or writing to the page. This would tend to force the child to center at the edge of the paper or book, conflicting with his freedom to move visually over the page (see Figures 87 and 88). If working surfaces have light colored "solid" or pigmented finishes with reflectances approaching those of the task, the center of gross contrast would be the edge of the desk to the floor, which would also interfere with the child's freedom to perform. In view of both of these, the best working surface would be one whose reflectance would approach that of the task and would have distributed

over it a light, but visible asymmetric pattern to break up the critical definition of the working surface edge against the floor. This means that the most visually efficient working surfaces are clear-finished, light, natural woods with a light asymmetric wood-grain pattern, or other materials finished in the reflectance range of those woods with an added asymmetric pattern to produce the same effect as the wood grain.

The closer a task approaches the child, the more critical becomes the effect on his performance of contrast between task and its supporting surface. With the maximum limits of contrast in the central visual field restricted to not over 1 to 3, a more desirable contrast ratio for working surface to close tasks would be a limit of 1 to 2. The working surface reflectances making for such a limit would necessarily have a range extending from not less than one-half the highest typical task reflectance, to not over the lowest typical task reflectance. This would provide a range of from 30% to 55%. These would still be within the maximum range of contrast tolerances when the child has those occasional tasks whose reflectances drop as low as 40% or go as high as 80%.

Whether working surfaces in a room should be confined to a single reflectance is a question that can easily be answered by turning to the light diversity in

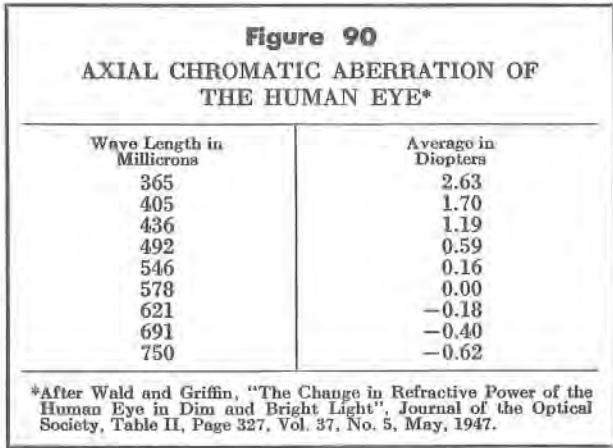

a daylighted room. If wood is chosen for those surfaces, instead of using expensive highly selected woods to get a single reflectance value, there can be a statistical scattering of reflectances over the permissible range (30% to 55%) in order to take advantage of the economies possible in using unselected light woods for desk and table tops. Even with optical controls at the windows, there is always more light falling on working surfaces next to the windows than there is on surfaces near the inside wall. While this diversity, with light-directional glass block, or diffusers, averages only 2 to 1, and is not particularly significant as far as light distribution is concerned, it does have an effect on the appearance of desk tops as an observer looks across a room. The amount of light reflected back from a surface determines its comparative appearance or brightness, with "incident light times the reflectance" determining the brightness of a surface. By having a range of reflectances, the surfaces of lower reflectance can be placed near the windows and those of higher reflectance can be placed towards the inside of the room. These surfaces will then be more uniform in appearance than if they all had the same reflectance. On the other hand, a single reflectance for all working surfaces will present a range of brightnesses in the room equal to the diversity of their incident light across the room. In other words, the more economic woods provide the more visually-efficient surfaces.

Color. Color for decoration in a working environment is too complex a subject to discuss in limited space. However, when general light levels reach those now represented by currently recommended practices, the color sense in vision has certain physiologic and psycho-physical functions or expressions seemingly independent of those of the light sense. Some of these should at least be indicated here.

The human eye, unlike the modern camera, is not color-corrected. This lack of color correction is expressed in a number of ways—in some "seeing" situations to the advantage of the individual, but in many visual tasks to his distinct disadvantage. It is this lack of color correction which makes for the physiological

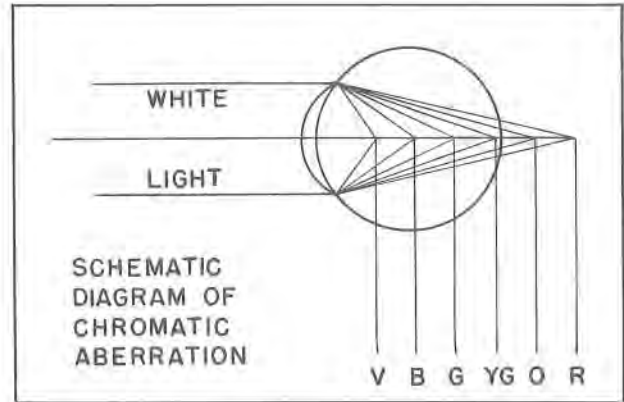

Figure 91

The eye, not being color corrected like a camera, brings various wave-lengths of light to focus at different points in relation to the retina. The extent and significance of this is indicated in Figure 90. The use of deep or saturated background colors, reflecting predominant wave lengths significantly displaced in relation to the retinal placement of the task stimulus, and the use of light sources of a color temperature radiating wave lengths focusing differently from task placement, produces visual changes in the apparent size of the task elements and apparent location of the task in space, inducing visual distress, misinterpretations, and disturbances of needed body balance.

processes expressed as the psychological effects of "warm" and "cool," "stimulating" and "relaxing," "approaching" and "receding" colors. It is through these psycho-physical mechanisms that people are conditioned to color likes and dislikes. But it is also through the magnitude of some effects of this lack of color correction that poorly chosen colors for classrooms, as represented by both color of background and color temperature of incident light, can hamper, if not damage, the development and achievement of children in school.

Because of the chromatic aberration of the human eye, light of different wave-lengths falls to focus at different points along the axis of the eye. The nature of this is shown in Figure 91. The intensity of the sensation by different kinds of light is not a function of the light stimulus alone, but varies also with the wave-length. As a consequence of this, some wave-lengths have a greater luminosity than others. Yellow-green has the greatest luminosity, so when the eye is light-adapted, the eye at rest accommodates to yellow-green (5500 to 5600 A), with shorter wave-lengths falling to focus ahead of the retina, and lower wave-lengths behind it. Hence, the "static" eye is myopic for radiation shorter than yellow-green, and far-sighted for radiation, or color, longer than yellow-green—a situation which in action it attempts to overcome. The extent of these differences is shown in the table, Figure 90. In incident light, or a reflecting surround, providing a continuous spectrum of equal energy (which would mean a black-and-white world), this difference means very little. But in a world of color, however, and especially in an artificial surround

where most tasks are near and sustained, and background colors and incident light are seldom planned in keeping with the required localization and accommodation for the tasks, this difference appears to be very significant.

In the "dynamic" eye—one that is working on tasks—as accommodation changes, (or as the task approaches or moves away from the eye), the wave-lengths of light falling to focus at the retina also change, according to whether the accommodation resulting is greater or less than that for yellow-green. Accommodation also tends to change in keeping with the predominant wave-lengths of the task-incident light, and also the wave-lengths represented in the major color of the surround. If background colors are too saturated, or if the task-incident light "peaks" too much at some wave-lengths, the accommodation forced by the dominant luminosity of these colors can interfere with the accommodation, or latitude of accommodation, required by the task. The eye then operates to overcome the effect of the colors by functioning in a hyperopic direction to reduce the effects of short radiation and in a myopic one for long radiation. While the nature of chromatic aberration in the eye is such that it interferes only a little with general identification of detail, its interference with spatial localization, optico-kinetics, and freedom of performance can be great, and these adverse effects must be avoided in working environments of the developing child.

How extensive this interference can be has been shown in a number of studies. Among these has been a yet unpublished study made for the writer by the laboratory of experimental psychology at Ohio State University.²⁰ This study shows a marked and functionally significant change of apparent size of objects under different color temperatures, and with changes in background color. These changes varied with the distance of the test object from the observer; with differences between no color and color in the background; and with various changes of color temperature in both background and incident light on the task. Some of these changes varied as much as increases of apparent size of 37% at common classroom working distances, up to 67% at greater distances. Other studies conducted for the writer have shown apparent location in space of tasks similarly affected

20. Unpublished Study under direction of Dr. Samuel Renshaw, Luminall Fellowship, Department of Experimental Psychology, Ohio State University, 1948-49.

up to magnitudes indicated in Figure 90. When it is recognized that as little as a half diopter of change in the eye can represent the difference between needing or not needing glasses when the difficulty lies in the eye, the significance of these spatial shifts and distortions of apparent size becomes obvious.

Because of effects of chromatic aberration, background colors in classrooms should be more apparent than real. They should tend to be desaturated or "grayed," without being drab; and, their reflected light should distribute well over the spectrum with their apparent color tending to be near the center of it, varying only enough to compensate for room orientation and light differences due to exposure. Different colors used in a room should not vary significantly in luminosity, thereby forming secondary attention centers. Their reflectances should be high to offset such variations. Background colors should not conflict with color in the purposeful materials of the child's experiences in learning situations. They should, rather, help give these colors full value so that each color experience of the child will be as near optimum as can be attained. Finally, because chromatic aberration can be put to use to increase the latitude of the child's visual performance, the illumination in far-seeing situations should be higher in color temperature than that for close visual tasks.

Chalkboards. Work done by Weston in England, and by others, tends to show that reverse contrast in some situations is more advantageous to seeing than normal contrasts. This would apply particularly to chalkboard tasks, which means that chalkboards should be darker than the details of the crayon or chalk used upon them. However, to avoid adverse contrasts with other tasks, the lowest reflectance of chalkboards must be within one-third the reflectance of other tasks and of background walls, or approximately 20%-24%. The best color for chalkboards would be one minimizing the effects of chromatic aberration. The average distance from children to chalkboard approaches the distance for the optical "infinity" of the eye—6 meters; consequently the best color would then be in the range of yellow-green. Because the reflectance of the board must be less than the general reflectances of the room, the spectral centering of the board color should be at the lower or shorter radiation end of the yellow-green range to offset any loss of luminosity due to a possible dark-adaptation or Purkinje shift.

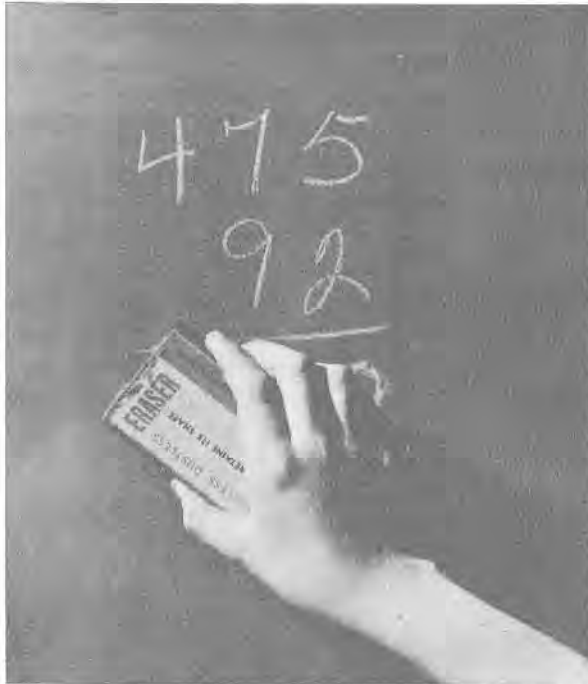

Figure 92

While research tends to show reverse contrasts are best for chalkboard seeing tasks (light on dark), chalkboard reflectances for effective seeing must be kept between 20-25%, rather than the 2-8% of "black" boards. The light must also be so distributed over chalkboards, as on other working surfaces, as to eliminate high contrasts, apparent shadows, and specular reflection.



Figure 93

With evenly distributed, shadow-free lighting, best visually-centered chalkboard tasks are performed at the desirable reflectances, when the chalkboard tends to reflect the spectrum of chlorophyll, adjusted for the eye adaptation to the reflectance of the board (allowance for any tendency towards a "Purkinje shift"). This color then eliminates adverse "chromatic displacement" of background.

BRIGHTNESS RESULTS

Figure 96 illustrates the brightness results obtained in an experimental renovation of three identical classrooms in a thirty-year-old building.²¹ Four rooms were used in the tests, one as an unchanged control room, and three for testing renovation procedures. Each room was identical in size, and had the same window area and exposure. The light measurements were made simultaneously in all four rooms so as to measure the effect of the changes in each room under the same outdoor light. The three experimental rooms were redecorated identically according to the reflectance patterns shown in Figure 89. Black chalkboards, however, were used in the rooms.

One of the redecorated rooms was left with clear-glass windows, in order to evaluate the effect of redecoration alone. The second room was redecorated and equipped with a single row of diffusers similar to those shown in Figure 65; and the third room was redecorated and the fenestration was changed to include light-directional glass block and a hooded vision strip according to the plan shown in Figure 80. The diagrams in Figure 94 show the vertical brightness results that were obtained. The top diagram is the unchanged control room; the second one reports the brightnesses found at the same time in the room that was redecorated only. The third diagram gives the measurements in the redecorated and diffuser-equipped

room; and, the bottom graph covers the brightnesses found in the room with the light-directional glass block panel and the vision strip.

The significance of these changes is self-evident in these diagrams. Redecoration alone very dramatically increases light levels and reduces some of the harsher contrasts. However, the remaining contrasts are still somewhat out of visual tolerance. The light-directional glass block and the diffuser both serve, in an almost identical manner, to bring brightness differences down to acceptable ratios (in fact, they bring them considerably within recommended maxima for such ratios).

Similar effective results were obtained in the contrasts between task and field brightnesses in the binocular field of children facing forward in the rooms. For the middle seat location in the window row in each room, the measurements showed the following contrasts between field brightnesses and task. Control room: 50° left to task, 28.7 to 1; forward to task, 1 to 5.7; 50° right to task, 1 to 7.2, all exceeding tolerance. Redecorated room: 50° left to task, 14.5 to 1; forward to task 1 to 3.2; 50° right to task, 1 to 1.6, an acceptable pattern except in the left field, with even that considerably improved over the control room. Diffuser equipped room: 50° left to task, 3.0 to 1; forward to task, 1 to 2.4; 50° right to task, 1 to 2.4, all within recommended practices. Glass-block-equipped room: showed, 50° left to task, 2.3 to 1; forward to task, 1 to 2; and, 50° right to task, 1 to 2.1, a slightly smoother distribution than in the diffuser room. These and similar experiments have demonstrated conclusively the need of optical control of daylight and co-ordinated planning of lighting and decoration.

21. Reported in detail in the independent engineering appraisal of the experiment, Biesele, Folsom, and Graham, "Control of Natural Light in Classrooms," *Illuminating Engineering*, September, 1945.

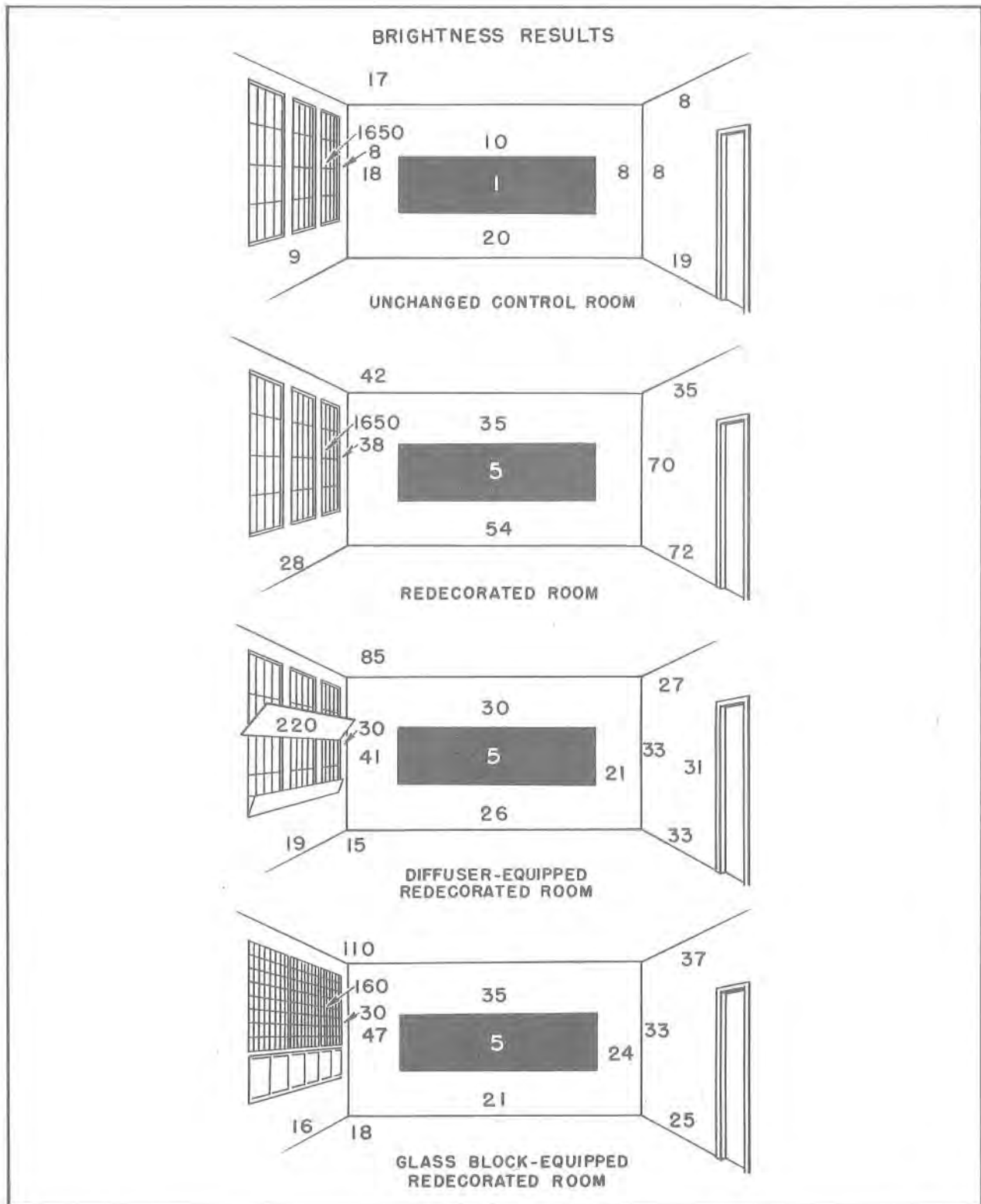

Figure 94

Brightness readings taken simultaneously in four rooms having the same dimensions, outside exposure, outside daylight, and same size fenestration. The top diagram is a typically decorated classroom like that in Figure 77. The second shows a room redecorated as in Figure 89. The third sketch shows a redecorated room, equipped with a single row of diffusers, and, the fourth diagram is a redecorated room with a light-directional glass block panel, vision strip, and hood, as in Figure 80.

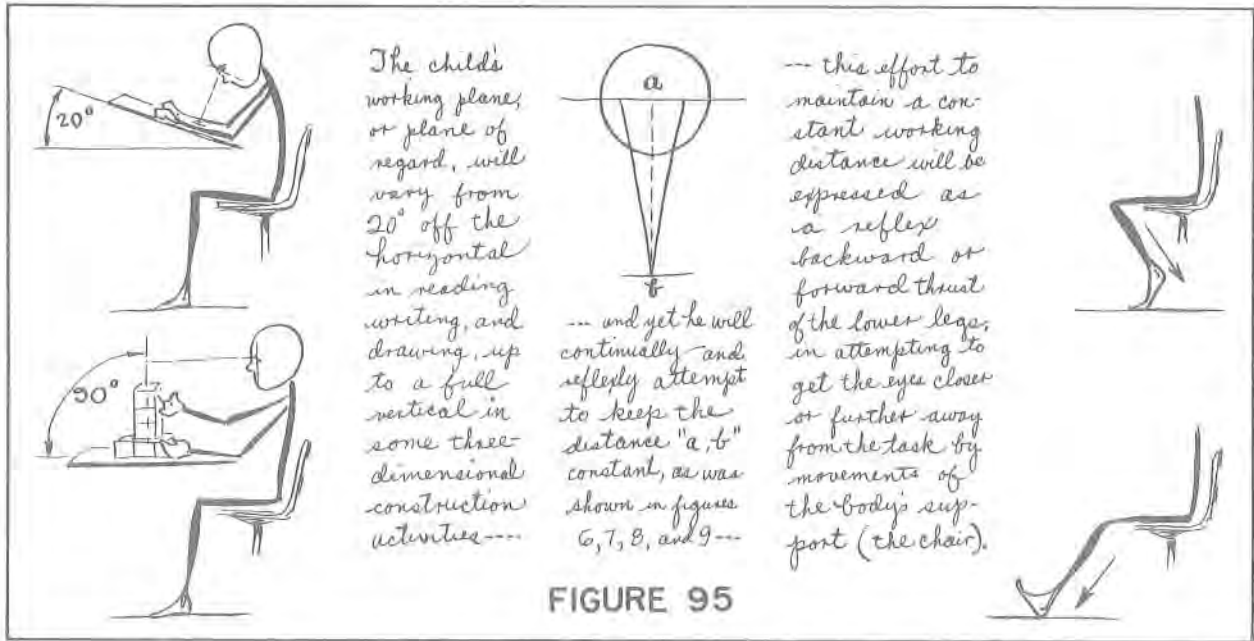

FIGURE 95

FURNITURE SELECTION

If co-ordinated planning of classroom lighting and decoration, permitting optimum freedom of orientation, is to have maximum value for school children, then desks, tables, seating, and other equipment at which they work in sustained, close visually-centered tasks must be designed so as not to defeat the advantages gained by such planning. The difficulties a child can acquire from his physical classroom surround can be just as much a product of the restraints upon freedom of needed action imposed on him by the furniture he uses, as they can be products of incitation to conflicting actions by the unco-ordinated energies of the surround. Furniture must be equally co-ordinated with lighting and decoration (and with the other forces and limits of the surround) to provide a unitary and dynamic physical environment.

Working surfaces and seating used for close visually-centered activities, as we saw in Part One, must be designed to fit the efficient, reflexly-determined body mechanics of such tasks. To perform a purposeful task effectively, and yet be free to grow and develop in all respects, the child must be supported for balance with gravity and the other forces of the surround; must be balanced to center freely on the various near and far and angularly different tasks he is required to perform from a seated position; must be free to maintain appropriate optical and motor relationships with his tasks; and, must be able to counterbalance effectively any manipulatory actions those tasks require. In addition, these balancing efforts must not hamper any basic physiologic functions, nor must they use energy excessively so as to limit the energy available for both vital needs and purposeful adaptation and learning. Just as the various energies of stimulation must distribute in the classroom so that the environmental vectors inciting action are so related to the organic vectors they

arouse, that their relationships provide physiologically appropriate axes of function, so seating and working surfaces must furnish support for the child and his tasks so as to permit optimum functioning on those axes without imposing energy-consuming stresses or warping strains.

Design and Dimension. Part One presented the essential reflexes and body mechanics entering into close visually-centered activities both on a plane and in three-dimensions. Figure 95 summarizes these as they are applicable to working surface positions and it also presents, schematically, some additional applications of body mechanics to chair design. In reading, writing, drawing, and other "two-dimensional" tasks, the working surface should tilt 20° out of the horizontal, and should be adjustable for height so that the inner edge will just meet the child's elbows as he leans forward to the balanced posture required by the close task he is performing. In modelling, construction, and other three-dimensional activities, the child needs a horizontal working surface. The height of this surface is determined somewhat by the size of the three-dimensional task in which the child is engaged, but in most such activities, at which the child is seated, the height of the working surface should be approximately the same as the child's hand height in his balanced position for plane surface tasks. This relationship can be seen by examining the first and last photographs in Figure 96.

Chairs should either be adjustable for height, or be of proper height for both a balanced pelvis and for minimum compression or restriction of soft tissues. With fixed-height chairs, it is much better for the child to grow out of a fitted size furnished him than be forced to grow into one of an initial height too large for him. At least three other chair adjustments are essential for full freedom of performance. Because the child, in uni-manual activities, rotates his trunk



Figure 96

These photographs illustrate the application of the principles shown in Figure 97 to a universal-type desk. They were shown in earlier sections with a detailed explanation. The photograph to the left shows the desk top horizontal for three-dimensional construction activities; the one to the right has the desk top at 20° for use in "plane" tasks; and the center picture shows an intermediate angle for special uses. Note that the seat has been reflexly adjusted to different lateral positions to meet the line-of-sight needs of the tasks.

with his preferred hand on the outside of the revolution both to counterbalance action and in order to center his activities off the medial plane of his trunk, the chair should be free to rotate with him in order to reduce the torque the child's rotational movements create in his lower back. In addition, as is shown in Figure 95, the chair must be free for sufficient forward-and-backward movement to reduce leg thrusts which the child expresses as he reflexly shifts his position medially to maintain a constant and optimum optical distance between his eyes and his center of attention on the task. Finally, because the lower curve of the child's back changes as his center of visual fixation moves from one on the desk to one horizontally forward, the backrail of the chair in contact with his lumbar or lower thoracic area must be movable so as to coincide with these changes in back curvature. It can be readily seen that the continual shifts of body base and position made to maintain a visual and postural balance in performing school tasks precludes the use of "saddle"-seat contours in chair design, because such contours restrain necessary movement. Instead, seat contours should be of a "bucket" or "cradle" type, with curves compounded in a manner to permit freedom of movement while maintaining as nearly as possible an even distribution of pressure over the portions of the buttocks and legs in contact with the chair seat.

Because body mechanics and organic dynamics enter significantly into producing optimum growth, well-being, and achievement in any school task—even when the actions are seemingly implicit—fixed-type and unadjustable equipment, such as screwed-down desks, rigid desk-linked chairs, chair-desks, and the

like (and equipment not adapted to the task to be performed, as described above) should be recognized as potentially damaging to both the child's physical well-being and his educational advancement when used in sustained, close visually-centered tasks. Rigid, fixed, and unadjustable seating and working equipment should never be used in those lower divisions of the school where either the physical or psychological growth of the child is rapid; and such equipment should be frowned upon in those activities which are primarily visually-centered on any level of education. Figure 96 illustrates a desk unit designed to incorporate all the principles mentioned here. It should be recognized, however, that no one piece of school furniture can be designed to meet every curricular need.

Finishes. Furniture finishes and reflectances were discussed at length in this section under "Decoration." Because of their importance, it might be well to repeat here, in summary, the essential factors of this discussion. Wood surfaces should be of light, unselected woods, finished to have a reflectance range of from not less than 30% to not over 55%. Wood finishes should be clear, free of opaque pigments which obscure the wood grain, and should give the wood a slightly warm, or "orange" appearance. Vertical supports and other metal parts and surfaces should have slightly warm but neutral-appearing finishes. Their reflectances should be inside a 1 to 3 ratio with those of the wood surfaces, but in any case should not exceed 30%.

Furniture Arrangement. Even with optically-designed controls at the fenestration which direct most of the working light upward and into the room and

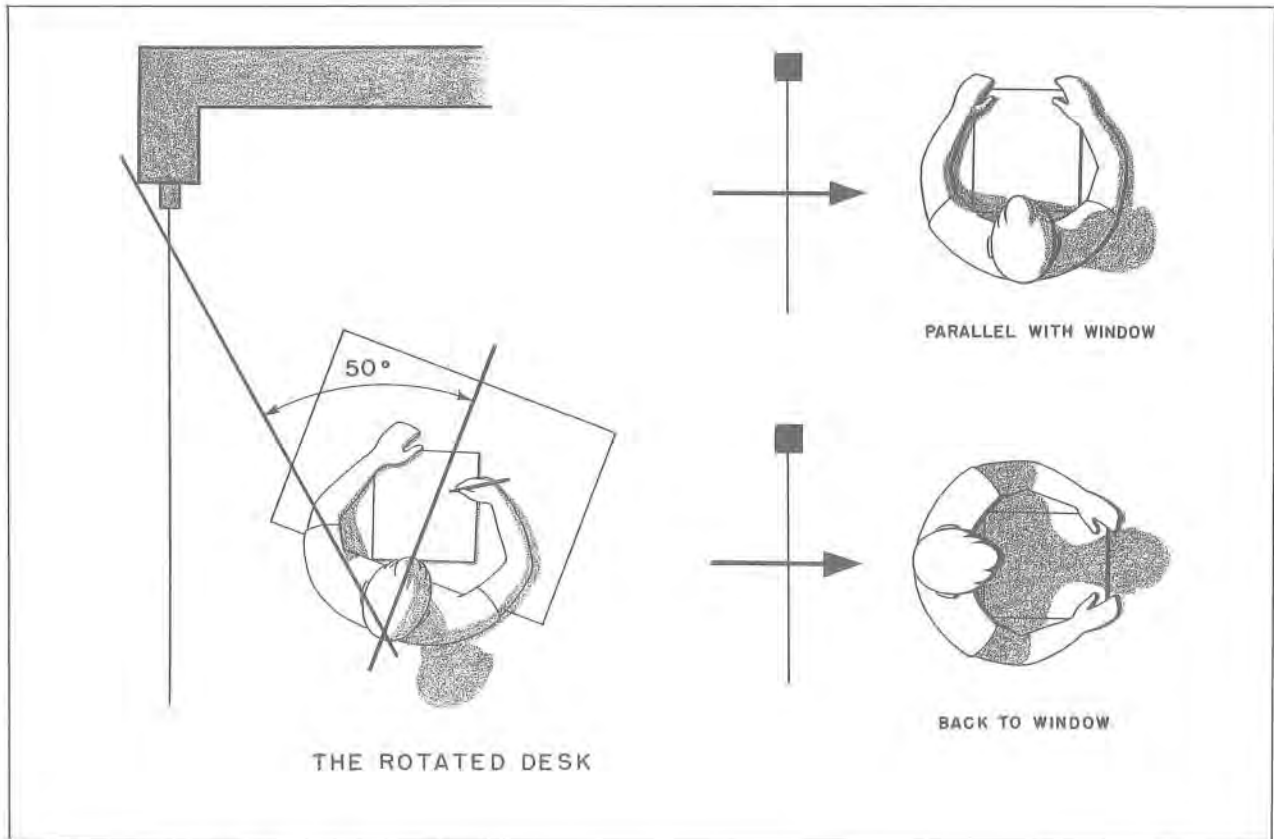

Figure 97

A schematic diagram of the 50° rotation of working surfaces away from the front limits of the windows in order to minimize body-shadows and provide a low-contrast binocular visual field in properly decorated rooms. The body shadows possible from light coming through the vision strip are illustrated in the two small sketches for both seating parallel with the windows, and with backs to the windows. This rotation should be made for close visually-centered tasks in both formally and informally arranged rooms.



Figure 98

A desk-top template method for rapid arrangement of desks and working surfaces for the 50° rotation diagrammed in Figure 97.

reduce window brightnesses to within the limits of children's tolerances in most seeing tasks, optimum performance levels in critical visual tasks are reached only when central-field (the middle 30°) or task brightness appears as great or slightly greater than the remaining visual field brightnesses. Low levels of window brightness are possible both with light-directional glass block and the diffusers previously described. However, the reflected brightness of tasks, desks, and walls will necessarily be somewhat less than that of the windows.

Added visual protection in critical seeing tasks can be given children by planned orientation of seating and working surfaces in relation to the fenestration. The child's binocular field, within which most contrasts even slightly beyond tolerance have a significant effect on performance, extends approximately 50° to

Figure 99

Four arrangements of formal rooms in which a 50° rotation has been applied to working surfaces. The upper plans illustrate applications in rooms where a desk of the type illustrated in Figure 96 has been used, and the lower two illustrate applications to rooms equipped with two-place tables. The left-hand diagrams show arced aisles, an arrangement easier to maintain; the right-hand plans show aisles parallel with the walls. This second arrangement is for use where local requirements demand straight or parallel aisles.

Many other applications of this 50° rotation can be made to other types of furniture, and for both formal and informal room arrangement.

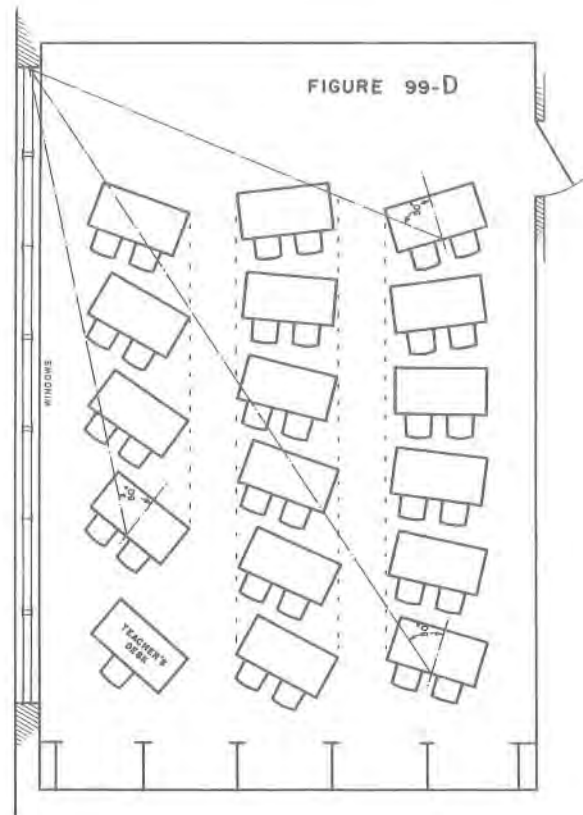
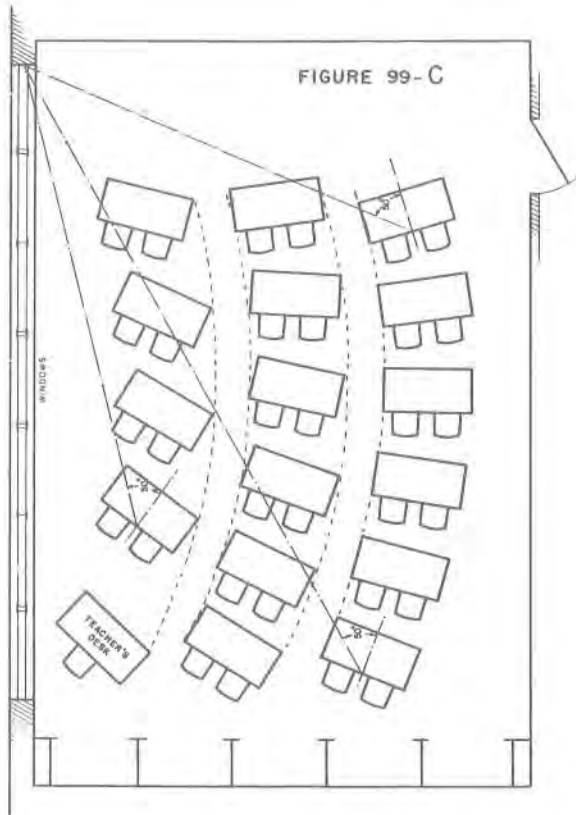
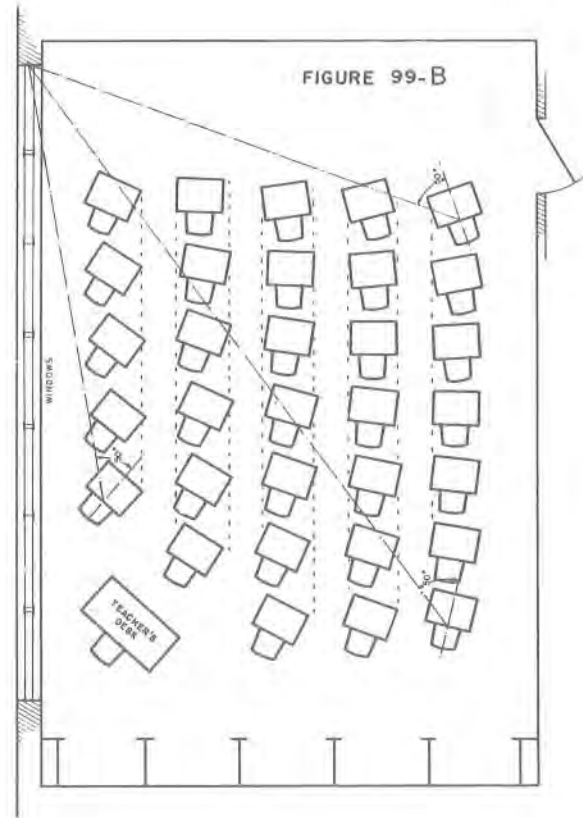
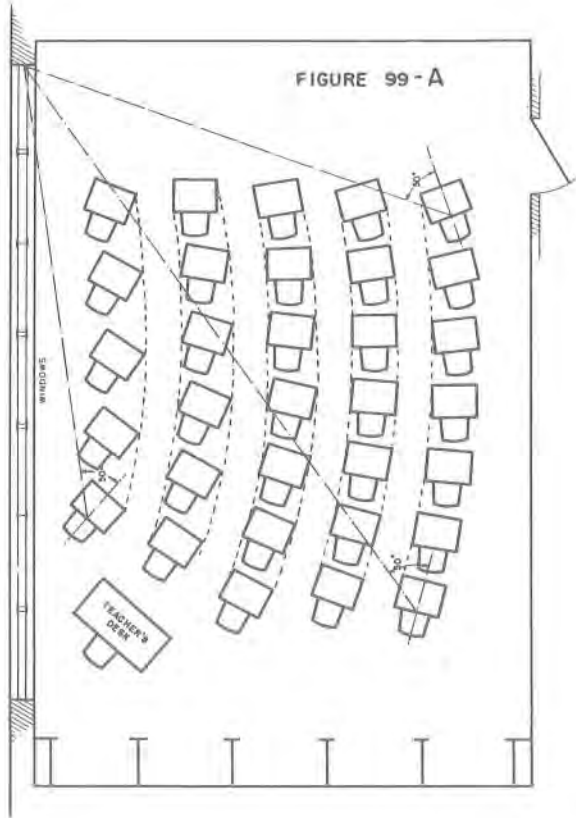

each side of the center plane of the head or line of sight. Advantage can be taken of this fact, in both formal and informal classrooms, to provide each child with protection from window brightness in sustained visually-centered activities. All that is necessary to do is to rotate seats and working surfaces so that the farthest limit of the windows which could fall within the child's visual field is 50° from his line of sight. This rotation can be accomplished by applying the formula diagrammed in Figure 97. Whether curricular method and classroom arrangement are formal or informal, every child is entitled to maximum visual protection in critical seeing tasks, and this 50° rotation is equally applicable to room arrangement in any curricular situation.

With the 50° rotation, no adverse body shadows are cast on working surfaces, because children's heads, shoulders, or trunks intersect part of the working light. Shadows possible in some other orientations are shown in Figure 97. The 45° rotation used in some classrooms, in which seating is arranged formally with straight rows running diagonal to the room, permits body shadows, cast by the horizontal light coming from the vision strip, on desks located within the front-inside diagonal half of the classroom, under the conditions shown in Figure 82.

The 50° rotation of working surfaces not only reduces the contrasts between the child's background visual field and his desk-centered tasks, and provides him a shadow-free working surface, but it also tends to increase the light on tilted-plane working surfaces and on vertical-desk tasks, in accordance with the cosine law of illumination. Application of this law shows that maximum task lighting is approached in daylighting as the angle between the child's line of sight and the line of light from the windows is reduced. Theoretically, the highest task brightness would occur when the child's line of sight coincided with the principal line of light from the windows. This condition would exist when the child was either facing the window or had his back to it. However, when he is facing the window, the child's visual field brightness can be higher than his task brightness, thereby reducing optimum performance. When his back is to the window the intersection of the line of light from the vision strip by his body can produce contrasty shadows on his task. With the 50° rotation of all desk surfaces within the room, each child's central visual field can be free of shadows, his task field can be brighter than its background field, and background contrasts can be controlled readily through decoration and equipment selection.

Room Grouping of Equipment. As was said earlier, no single piece of school furniture can be designed to meet every curricular need. A restraining influence on both curricular and child development, especially on the lower levels of education, has been the assumption that every child must have a desk of

his own. This has led to furnishing every child in the room with identical pieces of furniture, thereby restricting the floor space available for educational activities, or, requiring larger classrooms as knowledge of needed activities expanded. The only situations in which identical equipment for each child would be necessary would be those in which all children were engaged in the same activities, simultaneously, or where all the individual activities of each child, when not participating in group actions, were adapted to one specific type of furniture. Such situations are not in keeping with modern trends in curricular organization. Teacher-centered activities in which children are oriented in new educational experiences very seldom involve more than a third to a half of the group in the room at any one time. Individualized activities require different types of equipment at various times. And, group-centered activities vary in nature from time to time, with all the children seldom concerned in any activity at any one time.

A more logical method for room grouping of basic pupil furniture needed would involve a number of steps. First would come a curricular analysis to determine the types of day-to-day activities to be carried on in the room throughout the school year, with an estimate of the average number of children who will participate in any type of activity at any one time. This would be followed by a study to find the fewest number of basic types of furniture meeting all the needs of the children (both in body mechanics and in task support) in their various day-to-day activities. (In addition to pupil seating and working furniture, a study should be made of necessary storage, display, demonstration, and teaching equipment, as well as furniture for teacher use.) When basic types of pupil furniture necessary for the classroom program were worked out, then only that number of each type should be secured for the room as would be put to maximum use at any one time during the school day. Naturally, a reserve supply of each type of basic equipment should be kept in central warehousing for special occasions, and some central storage arrangement needed in that building for occasional use.

As an illustration only (and not to set a fixed pattern for furniture selection), an intermediate grade classroom with 30-pupil enrollment would probably find a basic furniture combination of 16 fully adjustable movable-type desks (as previously described), 4 two-place tables, a library table, and 24 individual chairs, much more useful as basic room equipment in the light of present curricular trends than 30 identical desks or tables. This would be in addition to individual storage equipment for each child's personal possessions, and the other equipment mentioned above. Some such method for basic furniture selection would make for better budgetary, plant, educational, and pupil economics than present methods of furniture selection.

Distributed by
Optometric Extension Program Foundation, Inc.
1921 E. Carnegie Avenue, Suite 3L
Santa Ana, CA 92705
(949) 250-8070

#XBJ100

\$10.00